

OSEK/VDX

Network Management

Concept and Application Programming Interface

Version 2.5.2

16th January 2003

This document is an official release and replaces all previously distributed documents. The OSEK group retains the right to make changes to this document without notice and does not accept liability for errors. All rights reserved. No part of this document may be reproduced, in any form or by any means, without permission in writing from the OSEK/VDX steering committee.

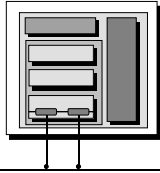

Open Systems and the Corresponding Interfaces for Automotive Electronics

Table of Contents

Introduction	3
Summary	4
1. Scope of the OSEK Network Management.....	5
2. Direct Network Management	7
2.1. Concept.....	7
2.1.1. Node Monitoring.....	7
2.1.2. Addressing.....	8
2.1.3. NM Infrastructure for Data Exchange.....	10
2.1.4. Standard Functionality.....	10
2.1.5. Configuration Management.....	10
2.1.6. Operating Modes	13
2.1.7. Network Error Detection and Treatment.....	14
2.1.8. Support of Diagnostic Application.....	15
2.2. Algorithms and Behavior	15
2.2.1. Communication of the Network Management System	15
2.2.2. NM Infrastructure for Data Exchange.....	19
2.2.3. Standard Tasks	20
2.2.4. Configuration Management.....	23
2.2.5. Example: Skipped in the logical ring	31
2.2.6. Example: Logical Successor.....	33
2.2.7. Operating Mode.....	34
2.2.8. Fusion of Configuration Management and Operating Modes.....	39
2.2.9. Alarms inside the Network Management.....	56
3. Indirect Network Management.....	60
3.1. Concept.....	60
3.1.1. Node Monitoring.....	60
3.1.2. Configuration-Management	61
3.1.3. Standard Task	62
3.1.4. Monitoring Mechanisms.....	63
3.1.5. Monitoring time-outs.....	64
3.1.6. Operating Modes	67
3.2. Algorithms and behavior.....	67
3.2.1. Configuration Management.....	67
3.2.2. Operating Mode.....	71
3.2.3. State Machine in SDL	73

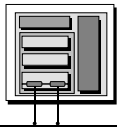

4.	System generation and API	85
4.1.	Overview	85
4.2.	Conventions for Service Description	86
4.2.1.	System Generation.....	86
4.2.2.	Type of Calls	87
4.2.3.	Error Characteristics.....	87
4.2.4.	Structure of the Description	87
4.3.	General Data Types	89
4.4.	Common services	89
4.4.1.	Standard Functionality.....	89
4.4.2.	Configuration Management.....	91
4.4.3.	Operating Modes and Operating Mode Management	97
4.5.	Services for direct NM	101
4.5.1.	Standard Functionality.....	101
4.5.2.	Operating Modes and Operating Mode Management	102
4.5.3.	Data Field Management	103
4.6.	Services for indirect NM	105
4.6.1.	Standard functionality	105
4.6.2.	Configuration Mangement	106
5.	Impacts upon OS, COM and the data link layer.....	106
5.1.	Error Codes.....	106
5.2.	Common impacts.....	107
5.2.1.	Requirements of the data link layer.....	107
5.2.2.	Requirements of OSEK Operating System (OSEK OS).....	109
5.3.	Impacts from direct NM	110
5.3.1.	Interface to the data link layer	110
5.4.	Impacts from indirect NM.....	112
5.4.1.	Interface to OSEK Communication (OSEK COM)	112
6.	History	114
7.	Implementation proposal (direct NM).....	115
7.0.1.	Overview of Internal Activities	115
7.0.2.	Specification of Internal Activities.....	117
7.0.3.	NMPDU	122
7.0.4.	Scalability.....	127
7.1.	Implementation proposal (indirect NM).....	129
7.1.1.	Scalability.....	129
7.1.2.	Implementation hints.....	130
7.1.3.	Summary of SDL state diagram graphical notation	132
7.2.	Outlook.....	133
8.	Index	135

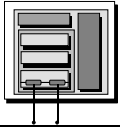

Introduction

There is an increasing tendency for electronic control units (ECUs) made by different manufacturers to be networked within vehicles by serial data communication links.

Therefore, standardization of basic and non-competitive infrastructure in ECUs aims at avoiding the design of unnecessary variants and saving development time.

In the scope of the OSEK/VDX co-operation, the Network Management system (NM) provides standardized features which ensure the functionality of inter-networking by standardized interfaces.

The essential task of NM is to ensure the safety and the reliability of a communication network for ECUs.

In a vehicle a networked ECU is expected to provide certain features:

- each node must be accessible for authorized entities
- maximum tolerance with regard to temporary failures
- support of network related diagnostic features.

At a basic configuration stage, NM implementations complying with OSEK specifications must be implemented in all networked nodes. This implies a solution for NM which can be implemented throughout the broad range of available hardware offered in today's ECUs.

Therefore, the status of the network must be recorded and evaluated uniformly at all ECUs at intervals. Thus each node features a determined behavior as regards the network and the application concerned.

OSEK NM offers two alternative mechanisms for network monitoring

- indirect monitoring by monitored application messages, and
- direct monitoring by dedicated NM communication using token principle.

However, the use of these mechanisms is up to the system responsible. Processing of information collected by these mechanisms must be in accordance with requirements as regards to the entire networked system.

System status

In view of the application, NM comprises two standardized interfaces:

- Software: Application program ↔ NM
- Network behavior: Station ↔ Communication medium

The resulting entire system is open. Thus, it can adapt to new requirements within the restrictions defined by the system design.

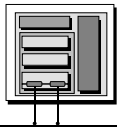

Remarks by the authors

This document describes the concept and the API of a network management, which can be used for ECUs in vehicles. It is not a product description which relates to a specific implementation.

General conventions, explanations of terms and abbreviations have been compiled in the additional inter project "OSEK Overall Glossary" which is part of the OSEK Binding Specification.

Summary

In order to achieve the essential task of a network monitoring, i.e.

- ensure safety and reliability of a communication network for ECUs,

OSEK NM describes node-related (local) and network-related (global) management methods. The global NM component is optional. However, it requires a minimum local component to be operational.

Therefore, the following services are provided:

- Initialization of ECU resources, e.g. network interface.
- Start-up of network
- Providing network configuration
- Management of different mechanisms for node monitoring
- Detecting, processing and signaling of operating states for network and node
- Reading and setting of network- and node-specific parameters
- Coordination of global operation modes (e.g. network wide sleep mode)
- Support of diagnosis

There are two main parts within the document: *Direct Network Management* described by Chapter 2 and *Indirect Network Management* described by Chapter 3. Both chapters describe the concepts, the algorithms and behavior.

The Subsections *Concept* describe the fundamental aspects of the configuration management, the operating states and operating state management.

The Subsections *Algorithms and Behavior* describe the protocol used for communication between nodes.

Chapter 4 describes the *Application Programming Interface* comprising the pure specification of the services offered by NM for both direct and indirect. Input and output data, the

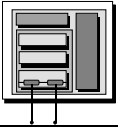

functional description, particularities, etc. are described for each service. Furthermore *System Generation* services are described within this chapter.

Chapter 5 describes *Impacts on OSEK Infrastructure* and gives a brief description of all requirements to OSEK Communication, OSEK Operating System and the data link layer for both direct and indirect NM.

1. Scope of the OSEK Network Management

Embedding of the Network Management

OSEK NM defines a set of services for node monitoring. The next figure shows how the NM is embedded into a system. It is also shown that the NM has to be adapted to specific requirements of the bus system used or to the resources of the nodes.

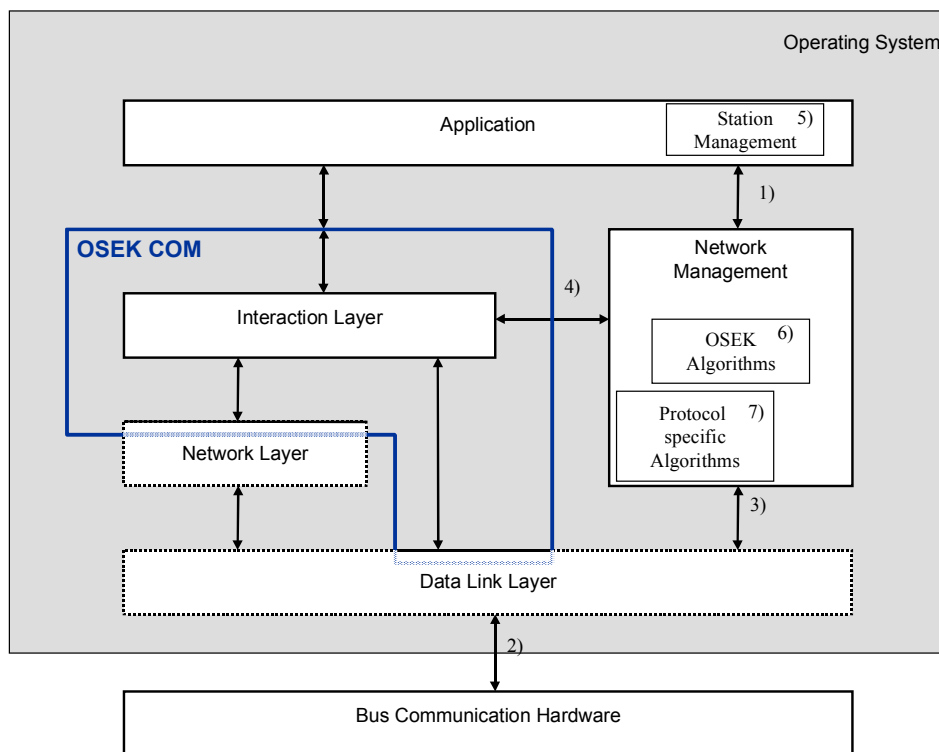
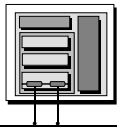

Figure 1 interface and algorithms responsibility

- 1) API, fixed by OSEK
- 2) several buses connected to one μ Controller
- 3) interface to DLL - COM specific, protocol specific
- 4) interface to COM Interaction Layer
- 5) station management (outside OSEK, see text below)
- 6) OSEK algorithms
- 7) protocol specific management algorithms



OSEK NM

- interface to interact with the application (API)
- algorithm for node monitoring
- OSEK internal interfaces (NM <-> COM, ...)
- algorithm for transition into sleep mode
- NM protocol data unit (NMPDU)

adaptation to bus protocol specific requirements

- CAN, VAN, J1850, K-BUS, D2B, ...
- error handling, e.g. bus-off handling in a CAN, transmission line error handling
- interpretation of the status information, e.g. overrun or error active/passive in a CAN

adaptation to node resources

- scaling of the NM as a requirement of the node
- application specific usage of the NM services

adaptation to hardware specific requirements

- adaptation to a protocol circuit and a physical layer circuit
e.g. switching the bus hardware to one of the possible physically power save modes

station management (system specific algorithms)

There are a variety of additional tasks to co-ordinate a network. Those are not described by OSEK, since they are system dependent. Hence these tasks are done by the application, e.g. by a module called station management.

Philosophy of Node Monitoring

Node Monitoring is used to inform the application about the nodes on the network. Thus the application can check with the appropriate service if all stations required for operation are present on the network.

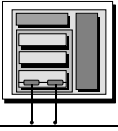

2. Direct Network Management

2.1. Concept

2.1.1. Node Monitoring

OSEK NM supports the direct node monitoring by dedicated NM communication. A node is a logical whole to which a communication access is possible. A micro processor with two communication modules connected to two different communication media (e.g. low speed CAN and a high speed CAN) represents two nodes from the OSEK point of view.

The rate of the NM communication is controlled across the network (minimization of bus load and consumption of resources) and the messages are synchronized (avoiding negative effects on application data by message bursts).

Every node is actively monitored by every other node in the network. For this purpose the monitored node sends a NM message according to a dedicated and uniform algorithm.

Direct node monitoring requires a network-wide synchronization of NM messages. For this purpose a logical ring is used.

Logical ring

In a logical ring the communication sequence is defined independently from the network structure. Therefore each node is assigned a logical successor. The logically first node is the successor of the logically last node in the ring.

Thus the decentralized control of the overall amount of NM messages is ensured and the bus load due to these messages is determined. The communication sequence of the logical ring synchronizes NM communication. Any node must be able to send NM messages to all other nodes and receive messages from them.

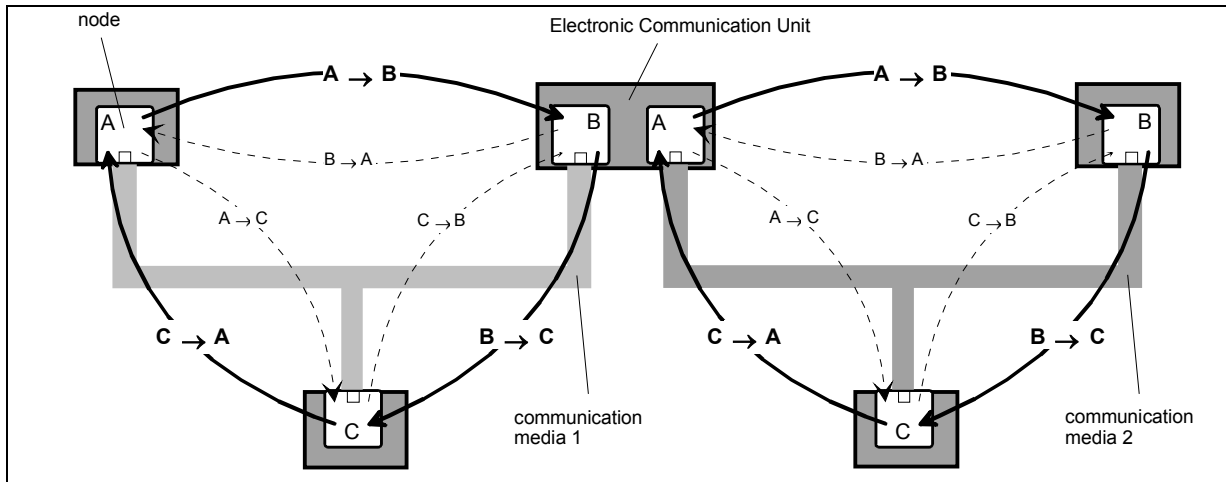
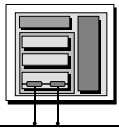

Figure 2 Infrastructure of the NM (logical ring), example with two buses

Principle

The direct NM transmits and receives two types of messages to build the logical ring. An alive message introduces a new transmitter to the logical ring. A ring message is responsible for the synchronized running of the logical ring. It will be passed from one node to another (successor) node.

Receive alive message	Interpretation as transmitter related registration to the logical ring.
Receive ring message	Interpretation as transmitter specific alive signal and synchronization to initiate transmission of own NM message according to the logical ring algorithm.
Time-out on ring message	Interpretation as transmitter specific break down

State of a node

A monitoring node is able to distinguish 2 states of a monitored node.

- node present → specific NM message received (alive or ring)
- node absent → specific NM message not received during time-out

A monitoring node is able to distinguish 2 states of itself.

- present or not mute → specific NM message transmitted (alive or ring)
- absent or mute → specific NM message not transmitted during time-out

2.1.2. Addressing

The status of nodes and of the network has to be acquired and evaluated uniformly at intervals. For this purpose, all nodes must communicate via their NM.

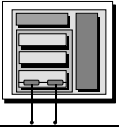

The NM communication is independent of the underlying bus protocol. Each node can communicate unidirectional and address related with any other node of the network. Therefore individual and group addressing of nodes is required.

Node addressing

Address related communication has to take into account receiver and emitter. Each node has a unique identification which is known in the network.

Each address related communication message contains certain data, the emitter identification and the receiver identification. OSEK NM does not specify the encoding of these components into selected bus protocols.

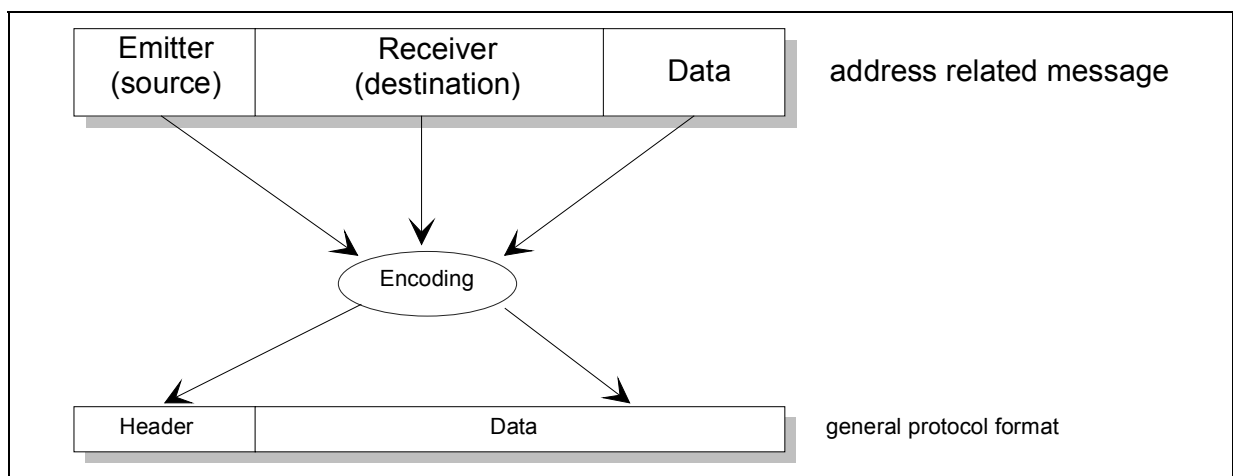
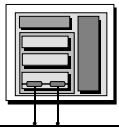

Figure 3 Exemplary representation of encoding of a NM communication message onto a general protocol format.

Individual addressing is implemented by node addressing using 1:1 connections. Group addressing is implemented by node addressing using 1:k connections ($k < \text{number of nodes in the network}$). For this purpose groups of receivers join group addresses.

Features of node addressing

- Each node is assigned a unique identification known within the whole network.
- Emitter and receiver identifications are explicitly included in the message.
- 1:k connections are implemented using group addresses.
- all messages are broadcast
- Integrating a new node in an existing network does not require notification of the existing nodes.



2.1.3. NM Infrastructure for Data Exchange

The NM supports the transfer of application data via its infrastructure (the logical ring). During the time delay between the reception and the transmission of the ring message the application is able to modify the data.

It is possible for the application to specify and implement management algorithms which are not provided by OSEK.

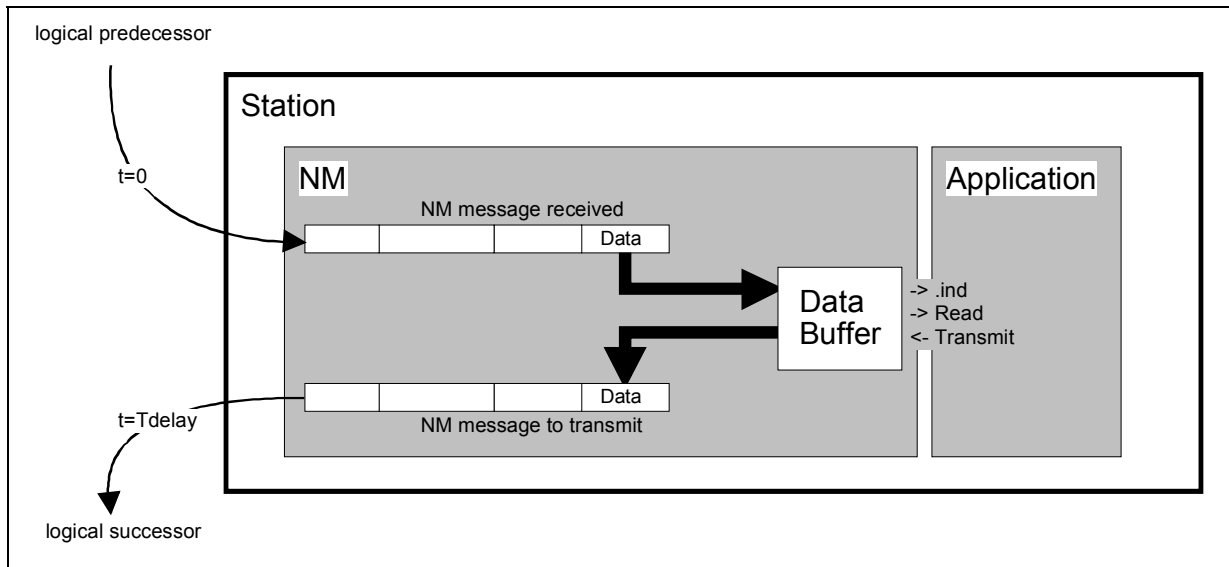

Figure 4 Mechanism to transfer application data via the logical ring

2.1.4. Standard Functionality

- Initializations are performed with any system start ("cold start"), e. g. timer services required from the operating system or communication hardware via the data link layer interface.
- Before the system is switched off - or switches off automatically - NM can be "shutdown", so that it can restore e.g. to the previously known network history when the system is started up again.
- The NM handles individual parameters, e.g. time outs and node identifications and, if necessary, version numbers to identify hardware and software versions.

2.1.5. Configuration Management

2.1.5.1. Network Configurations

In the absence of any faults, the networked nodes are activated at different times, e. g.:

- Stations on terminal 30 (permanent power): Wakeup via external event

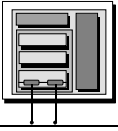

- Stations on terminal 15 (ignition): Switch ON via ignition key
- Stations with switch in supply line: switching ON and OFF at random, by driver

However, the actual configuration is also altered by faulty nodes and by defects in the communication network. Consequently, different actual configurations can result for the individual nodes in the course of time, which are additionally subject to external influences, e.g. actions by the driver.

As a rule, each node wants to start its application as quickly as possible. In view of NM, this means that an actual configuration is made available to the applications as soon as possible. Finally, it is up to the application to decide whether to start communication immediately after it has become operable, or whether to wait until a minimum configuration is detected by NM.

OSEK NM distinguishes between

- actual configuration:
set of nodes to which access is possible
- limp home configuration:
set of nodes which due to failure cannot participate in the logical ring

Therefore NM provides the following services:

- supply of the actual configuration
- comparison of a configuration with a target configuration
- indication of changed configuration

2.1.5.2. Detection of a Node in Fault Condition

Operability of a node

A node is considered operable in terms of NM, if the node participates in the logical ring.

Detection of failures

Only a node which is expected to be operable on the network can be recognized as having failed. The application recognizes node failures by comparison to the previous knowledge regarding the target configuration. There are several possible ways by which the application can acquire this knowledge.

- the last stable state of the actual configuration
- one or several programmed target configuration(s)
- the target/actual configuration determined by NM since system start up

The NM recognizes its own node as having failed if it cannot send via the bus or if it cannot receive any messages from the bus, i.e. it is no longer operable.

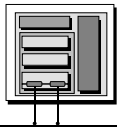

Another node is considered as having failed, if its NM message is not received or a NM message is received signaling an error state.

Reaction to a node failure

The NM of a node detecting a failure cannot distinguish whether the failed node is no longer able to communicate due to a line fault or due to a complete failure, without additional support. Any possible reactions, e.g. change over to redundant physical paths, must be specified together with entire system requirements.

2.1.5.3. Internal Network Management States

The OSEK NM is specified in a hierarchical way. The OSEK NM can enter the internal **states** listed hereafter:

- NMOff NM is shut off
- NMON NM is switched on
- NMShutDown Selective shut off of NM entity

NMON:

- NMInit NM initialization
- NMAwake Active state of the NM
- NMBusSleep NM is in sleep mode
- NMActive NM communication enabled
- NMPassive NM communication disabled

NMAwake:

- NMReset The operability of the own node is determined
- NMNormal Processing of direct node monitoring
- NMLimpHome Handling of failure in own node

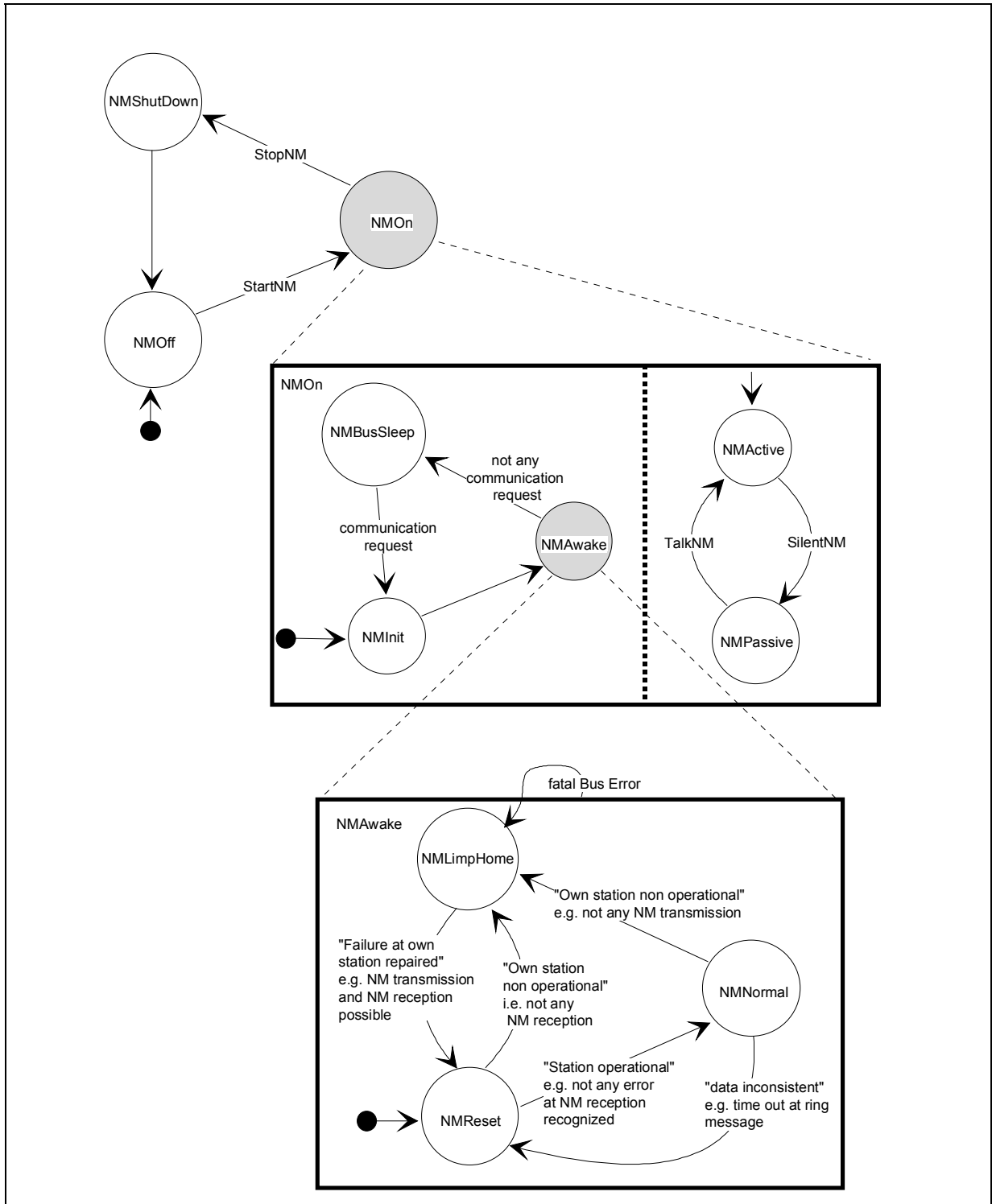
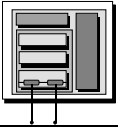
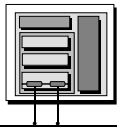

Figure 5 Simplified state transition diagram of the direct NM.

2.1.6. Operating Modes

The NM does not manage application modes, but exclusively manages NM operating modes. NM distinguishes two main operating modes. The modes of the NM are directly mapped to internal NM states.



NMAwake (NMActive)

In NMAwake the node participates in NM communication (logical ring) and monitors all nodes with a NM in NMAwake.

NMBusSleep

If a node is in NMBusSleep, it does not participate in NM communication. Depending on the hardware integrated in the networks, nodes can switch into NMBusSleep simultaneously.

The NM provides services for:

- adjustment of NM operation modes, and
- indication of NM operating modes.

2.1.7. Network Error Detection and Treatment

Only a limited part of the network activities is "visible" for the NM to detect errors.

The problem with error detection is that many errors appear identical from the node's point of view:

- The fact that a node on the network is not transmitting messages may be due to various reasons: it may be due to a control unit which has failed completely, or which has not been installed, the communication module or the bus driver may be defective, bus lines may have been disconnected or the connector may be defective.
- Great interest is attributed to any information which helps detect the cause of an error clearly, so as to enable replacement or repair of the faulty component or to initiate an NMLimpHome.
- Most errors occur during the course of assembly of the network during production and after repairs. If connectors are interchanged or contacts are pushed back, this will have fatal consequences for the network. Lines which are laid incorrectly, e.g. directly along components with sharp edges, can also cause operating malfunctions within the network.

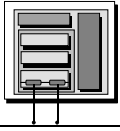

2.1.8. Support of Diagnostic Application

The NM supports the diagnostic application in the ECU by providing on request:

- status information of OSEK NM
- configuration information acquired

The NM is not responsible for recording the error history.

2.2. Algorithms and Behavior

2.2.1. Communication of the Network Management System

2.2.1.1. Network Management Protocol Data Unit

Any NM message contains the NM protocol data unit (NMPDU). The NMPDU defined hereafter represents the OSEK NM data to be communicated in order to control NM performance.

In order to fulfil all requirements with regards to communication and NM the NMPDU contains the following elements

- NM address field
 - source Id
 - destination Id
- NM control field
 - OpCode
- NM data field ^{optional}
 - application specific data

OSEK NM does not define network addresses. This parameter is dedicated to specific system design and therefore in the responsibility of the respective system developer.

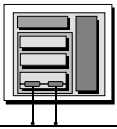

Address Field		Control Field		Data Field
Source Id	Dest. Id	OpCode		Data
mandatory				optional
res		Ring Message (4 types)		
		Alive Message (2 types)		
		Limp Home Message (2 types)		

Table 1 NMPDU - the representation of the data is not fixed
To guarantee the interoperability the data representation and the NMPDU encoding and decoding algorithms have to be fixed.

It is necessary to initialize the reserved area of the OpCode for future expansions. Whenever a network management message is received and transmitted after T_{Typ} , the reserved part of the OpCode is copied to the transmitted message.

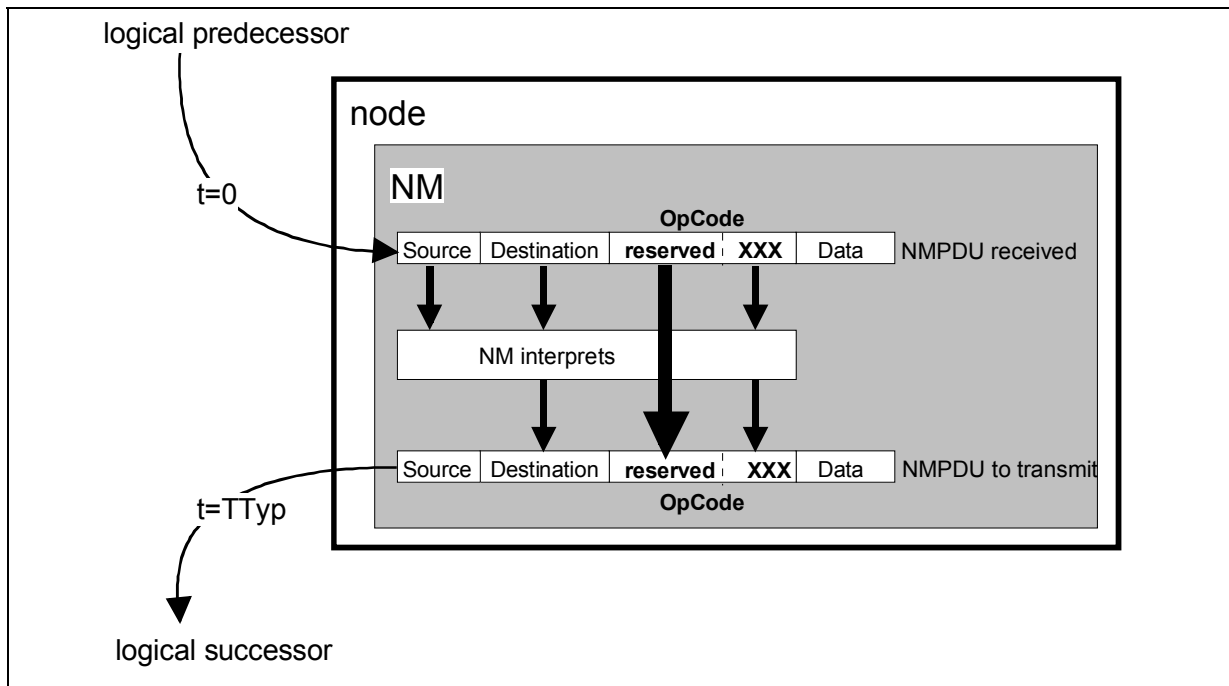

Figure 6 NM actions with the reserved area of the OpCode
XXX encoding of NM message types

Data consistency

The NM guarantees the data consistency of the NMPDU, e.g. during the reception of a burst of NMPDUs. The overrun of complete NMPDUs is possible.

NMPDU length

OSEK does neither fix the length of the NMPDU nor determine whether the data length is static or dynamic. Dynamic means that the length of the user data may change from NM message to NM message without affecting the specified algorithms.

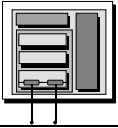

2.2.1.2. Addressing Mechanisms used by the Network Management

Each node in the network is assigned a global identification known by all nodes within the entire network.

NM communication is performed by directional communication of NM messages using 1:1-connections. The communication sequence complies with the definition of the logical ring in the respective network.

Therefore node addressing mechanisms are used for NM communication. NM protocol data units must include global identifications of source and destination among other data.

These identifications are transferred into address related NM messages. Each node transmits NM messages with its global node identification and addresses the receiver by specifying its global node identification, e.g. in the message header or in the data field.

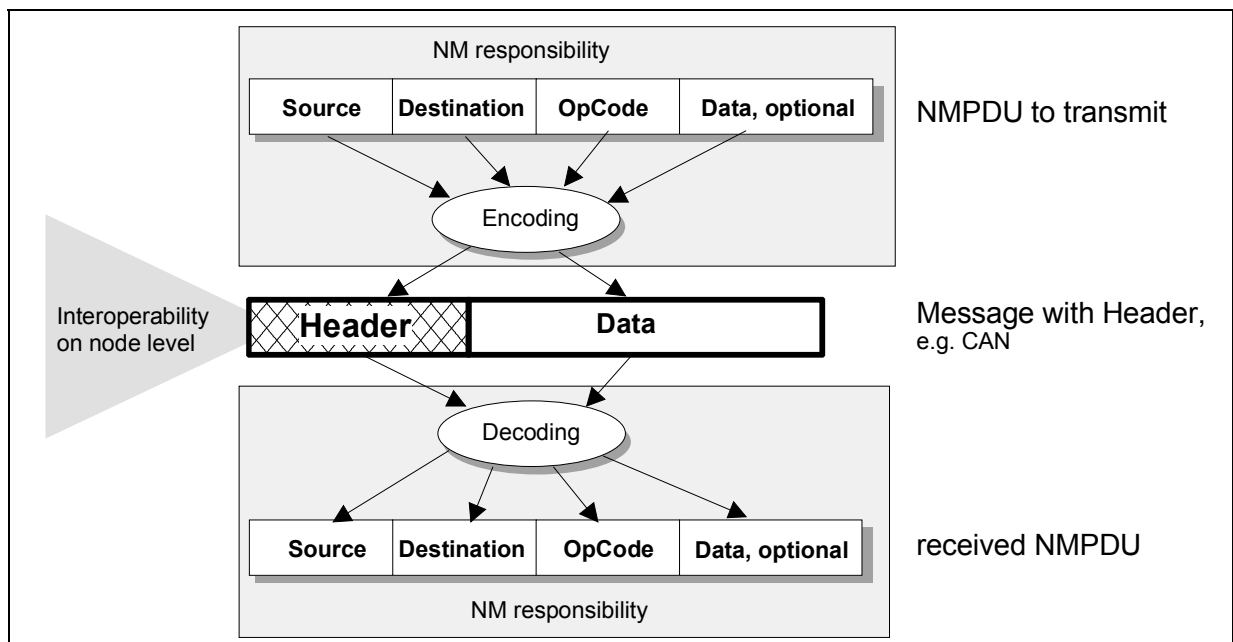

Figure 7 Encoding/decoding of the NMPDU to/from a message on the bus.

Examples for mapping node identifiers into address-related NM messages are given in the annex.

In order to simplify the handling of that amount of similar communication objects for NM communication the data link layer must provide the interface of a window communication mechanism. The window mechanism is defined by a WindowMask and an IdBase. However, the window mechanism has to be implemented by the respective NM system responsible.

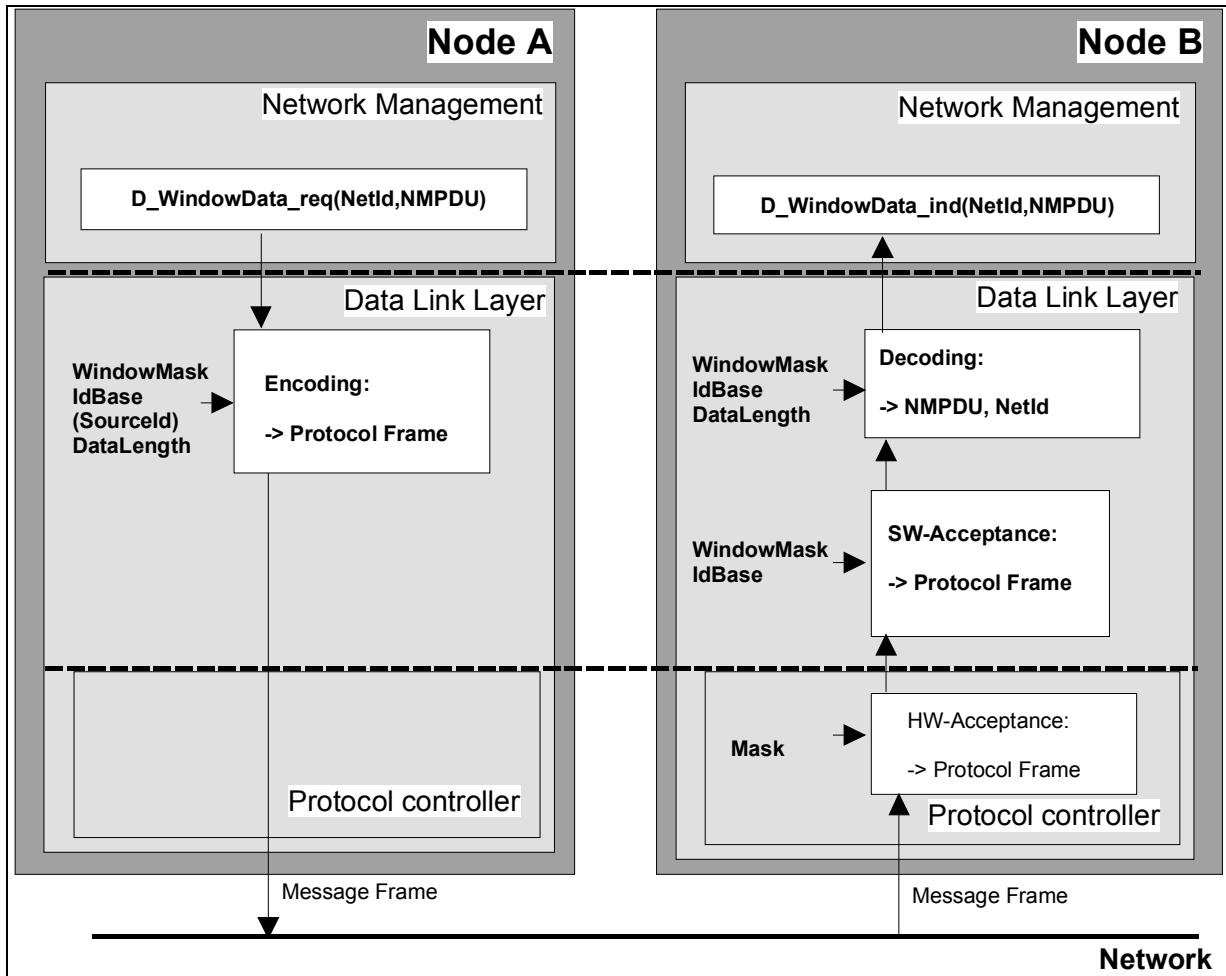
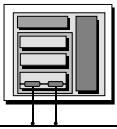

Figure 8 Transmission and reception of NM protocol data units (NMPDU).

Hint

It depends on the system generation functionality whether the parameter `DataLength` is static and located inside the DLL or whether it is dynamic and located inside NM.

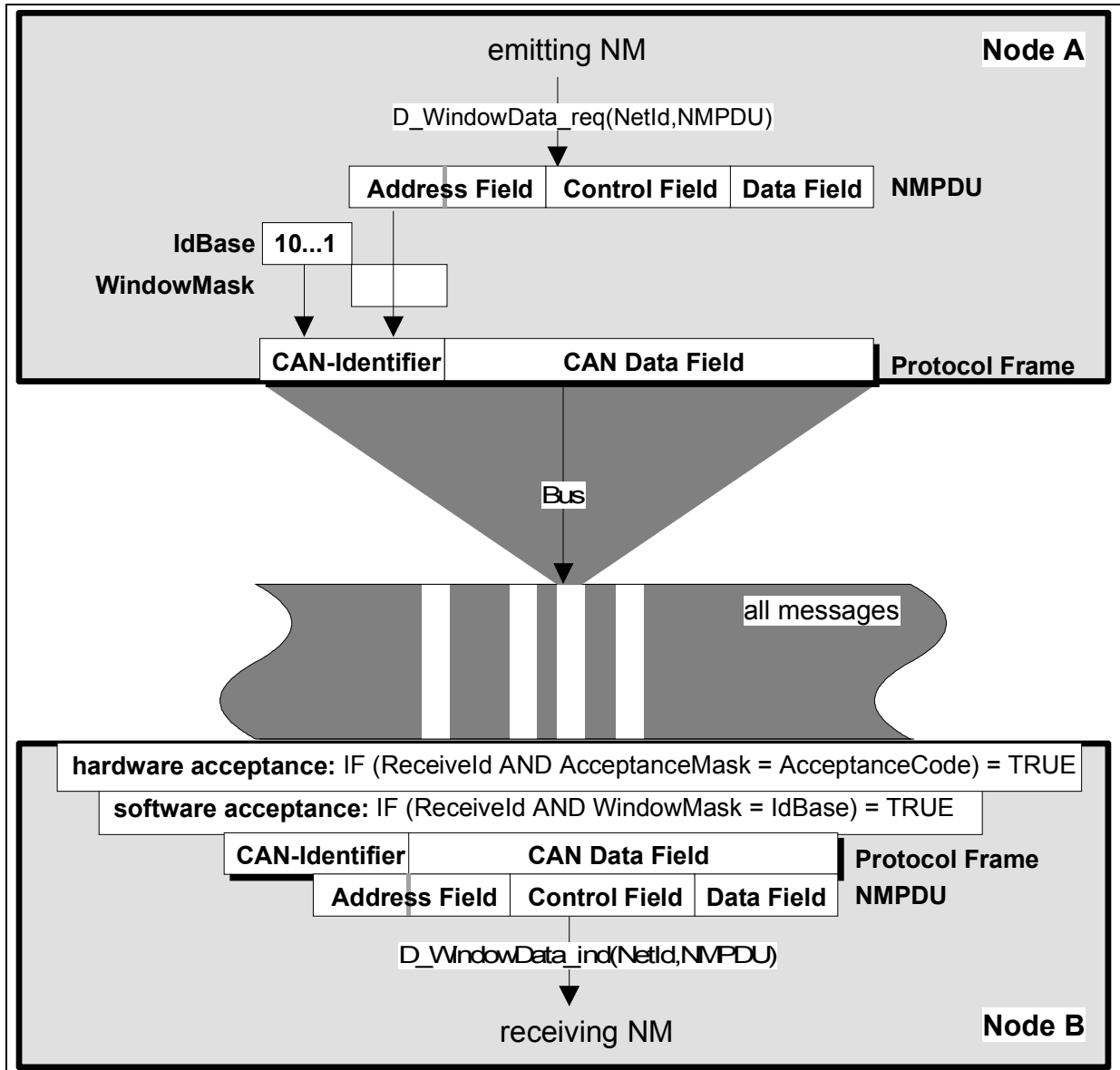
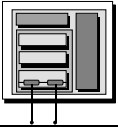

Figure 9 CAN-Example for the transmission and reception mechanisms of a NMPDU

The CAN identifier consists of two parts:

- 1) a fixed IdBase
- 2) some bits of the address field, chosen by a mask

2.2.2. NM Infrastructure for Data Exchange

The NM does not monitor the contents of the NMPDU data field. Every received ring message will be indicated to the application. The data field will be copied immediately into the buffer. The buffer will be copied into the data field, when the ring message has to be passed to the logical successor.

Data consistency

The NM uses several mechanisms to guarantee the data consistency:

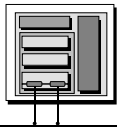

- the application can modify the ring data only between the reception of a ring message from the logical predecessor and the emission of the ring message to the logical successor
- The NM allows the access to the ring data only, if the logical ring runs in a stable state. The logical ring runs stable, if the configuration does not change and there is no NM message during the allowed access time of the application to the ring data.

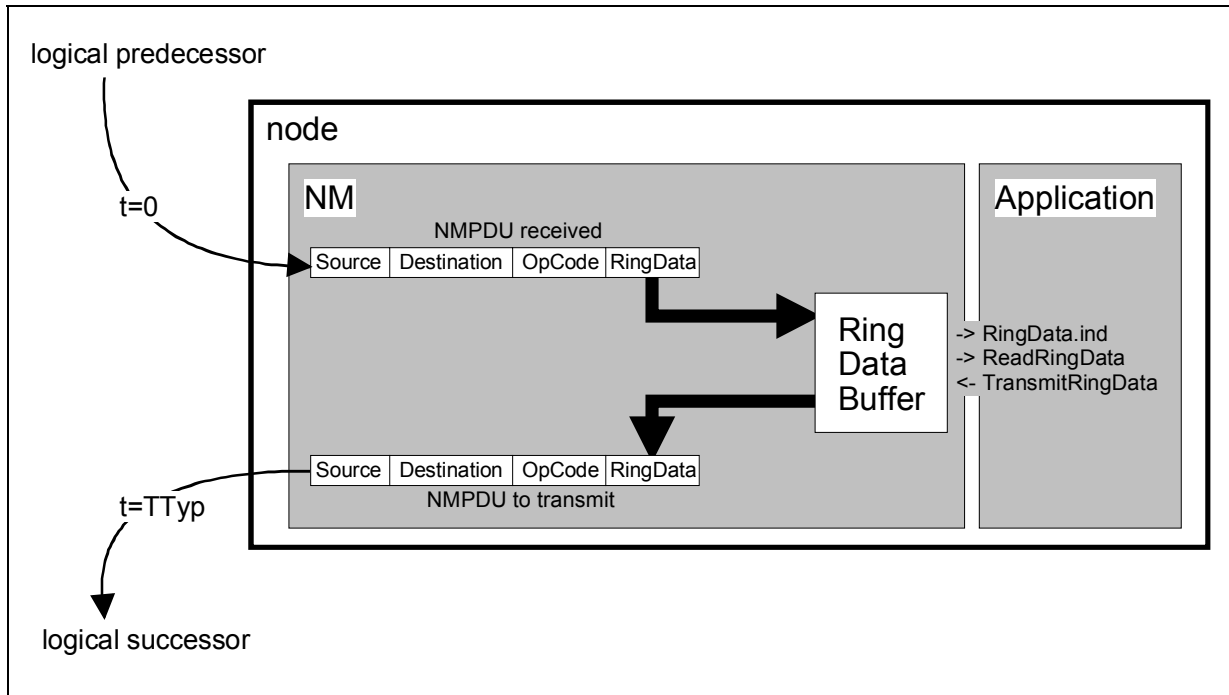
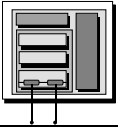

Figure 10 Handling of data exchange between NM and Application

2.2.3. Standard Tasks

2.2.3.1. Network Management Parameters

All NM parameters introduced in the concept description are known at compile time for a specific implementation and stored in the ROM of all ECUs.



NM Parameter	Definition	Valid Area
• NodeId	Relative identification of the node-specific NM messages	local for each node specific
• T _{Typ}	Typical time interval between two ring messages	global for all nodes
• T _{Max}	Maximum time interval between two ring messages	global for all nodes
• T _{Error}	Time interval between two ring messages with NMLimpHome identification	global all nodes
• T _{WaitBusSleep}	Time the NM waits before transmission in NMBusSleep	global all nodes
• T _{Tx}	Delay to repeat the transmission request of a NM message if the request was rejected by the DLL	local for each node specific

Table 2 NM parameters

To ensure the implementation of open and adaptive systems, all parameters of each node should be stored in a non-volatile, but erasable and writeable memory. Thus these can be adapted whenever required, e.g. by a diagnostic node. As regards transfer of parameters, reference is made to a specific download mode which is not dealt with in implementation specific system definitions.

2.2.3.2. Network Status

The NM informs the application on request about the network status it has acquired. The interpretation of these data is system specific and therefore with the application.

OSEK NM implementation should comply with minimum requirements to memory size which enables representation and storage of the network state, can appear as shown in the next table.

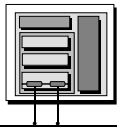

Network Status	Interpretation
• Present network configuration stable ¹⁾	0 No
	1 Yes
• Operating mode of network interface	0 No error ²⁾
	1 Error, bus blocked ³⁾
• Operation modes	0 NMPassive
	1 NMActive
	0 NMON
	1 NMOff
	0 no NMLimpHome
	1 NMLimpHome
	0 no NMBusSleep
	1 NMBusSleep
	0 no NMTwbsNormal and no NMTwbsLimpHome
	1 NMTwbsNormal or NMTwbsLimpHome
	0 using of Ring Data allowed
	1 using of Ring Data not allowed
	0 Service GotoMode(Awake) called
	1 Service GotoMode(BusSleep) called

Table 3 Encoding of the network status.

¹⁾ Configuration did not change during the last loop of the NM message in the logical ring

²⁾ Reception and transmission of NM messages successful

³⁾ e.g. CAN-busoff

2.2.3.3. Extended Network Status

The extended Network status is specific to the user.

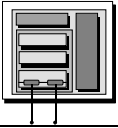

Extended Network Status	Interpretation
<ul style="list-style-type: none">Operating mode of network interface	00 No error ¹⁾ 01 Error, communication possible ²⁾ 10 Error, Communication not possible ³⁾ 11 reserved
<ul style="list-style-type: none">Number of nodes which participate in the monitoring algorithm "logical ring"	up to the user
<ul style="list-style-type: none">Number of nodes which signal its limp home	up to the user
<ul style="list-style-type: none">time since the logical ring is in a stable state	up to the user
<ul style="list-style-type: none">time since the logical ring is in a dynamic state	up to the user
<ul style="list-style-type: none">...	

Table 4 Example for the encoding of the extended network status.

¹⁾ Reception and transmission of NM messages successful

²⁾ communication via one wire

³⁾ e.g. CAN-busoff for a "long" time

2.2.4. Configuration Management

Direct node monitoring is based on decentralized configuration management. The respective procedures are described by one state transition diagram. This OSEK algorithm for decentralized configuration management can be used for:

- regular NM communication, i.e. transmission of ring messages according to the communication sequence
- exceptional NM communication, i.e. start up and limp home/failure modes

2.2.4.1. Timing Reference

Implementation of decentralized communication management requires several timing criteria to be respected. To the resulting time intervals a relatively high jitter may be applied in the individual nodes.

In order to minimize the negative effect on user software, NM must not require any sharp timing criteria in general. The following timing criteria apply with OSEK NM implementations:

T_{Typ} typical interval between two ring messages on the bus

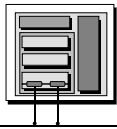

T_{Max}	maximum admissible interval between two ring messages on the bus
T_{Error}	cycle time in which a node signals that an error has occurred
T_{Tx}	delay to repeat the transmission request of a NM message if the preceding request was rejected

2.2.4.2. Monitoring Counter

To determine if a node is operational, the writing path and the reading path of the node should be checked explicitly by the NM.

This is accomplished most easily by indirect mechanisms, using monitoring counters which are incremented or decremented by different events. Their states - contents greater or lesser than the predefined limits - are considered as information pertaining to the node's readiness for operation.

2.2.4.3. State transition diagram

From the point of view of the application the basic states of OSEK NM are

- NMReset
- NMNormal
- NMLimpHome

NMReset

In NMReset, the node notifies its presence once in the network. For that purpose the alive message is transmitted. The NM then changes immediately over to NMNormal.

NMNormal

In NMNormal the NM tries to pass one ring message cyclically with T_{Typ} from one node to another one. If a node is unable to receive or to transmit any NM messages, it switches over into NMLimpHome.

NMLimpHome

In NMLimpHome the NM signals its limp home status by a limp home message cyclically with T_{Error} and repetitively until it is able to transmit its own ring message to the bus and until it is able to receive NM messages of other nodes correctly.

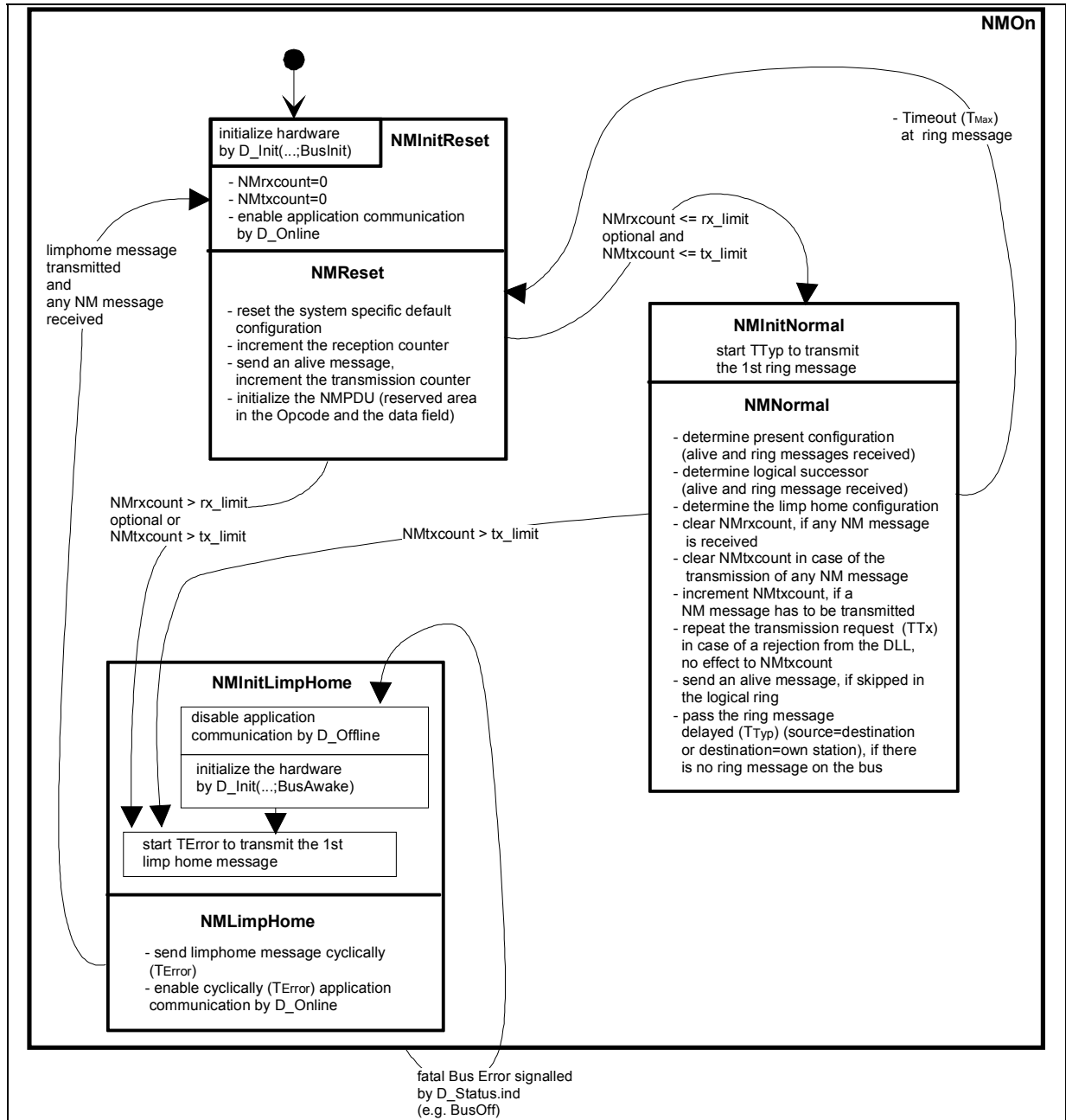
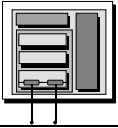
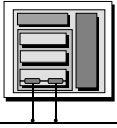

Figure 11 State transition diagram of the NM algorithms for initialization, start up and monitoring of a network (logical ring and limp home)

Hints

- Time-out T_{Max} in case of ring messages
⇒ another node in the logical ring has disappeared
- `NMrxcount`
This counter is used to detect a failure at the receive functionality of the NM.
- `NMTxcount`
This counter is used to detect a failure at the transmit functionality of the NM.
- enter `NMLimpHome`
This state is entered, if `NMTxcount` or `NMrxcount` is greater than system specific



limits (rx_limit, tx_limit). Typical value for rx_limit is 4 and a typical value for tx_limit is 8.

- leave NMLimpHome
This state is left, if the receive functionality and the transmit functionality is always available for the NM.
- node skipped
If a node is skipped it transmits an alive message asynchronously.

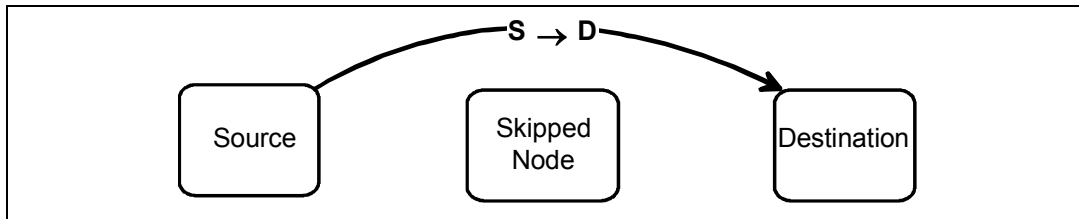

Figure 12 skipped in the logical ring

- system specific default configuration
"I am present at the network and I am my own logical successor"
- start up of the logical ring
By entering the state NMNormal every node starts the alarm T_{Typ} .
- registration of a node
Alive messages and ring messages are used to introduce a node in the network.
- delay T_{Tx}
A transmit request can be rejected by the lower communication layer and has to be repeated with a delay.

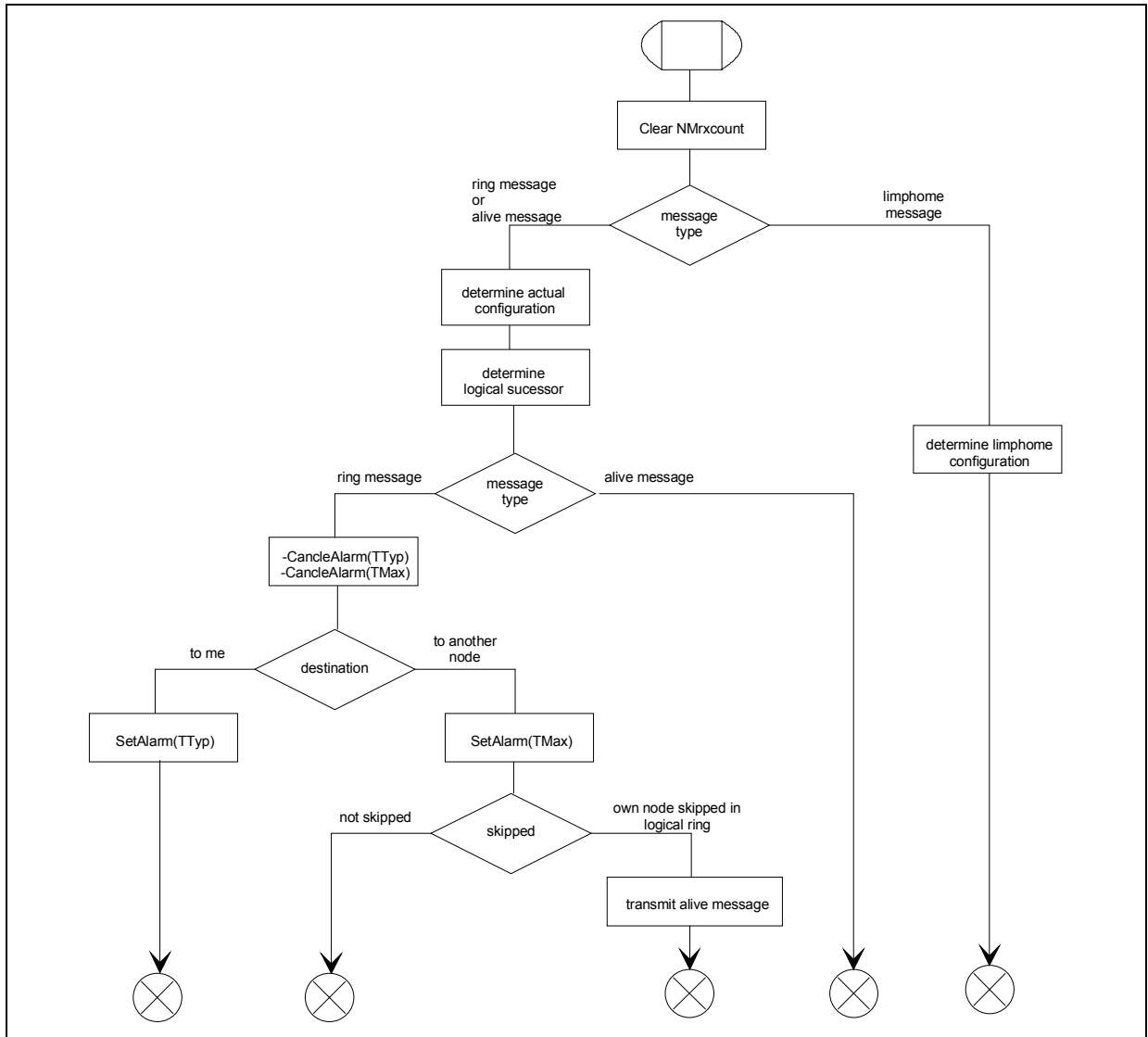
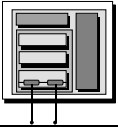
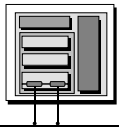

Figure 13 Actions during NMNormal in case a NM message is received "at a time"

During the establishment of the logical ring NM transmits and receives alive messages and ring messages from the network interface.



Starting with a stable NM communication in the logical ring the management of two configuration failures

- dynamic introduction of a "new" node in the NM communication (here: node no. 3)
- failure condition of a node leading to its disappearance from the logical ring (here: node no. 1)

are shown in the figure below.

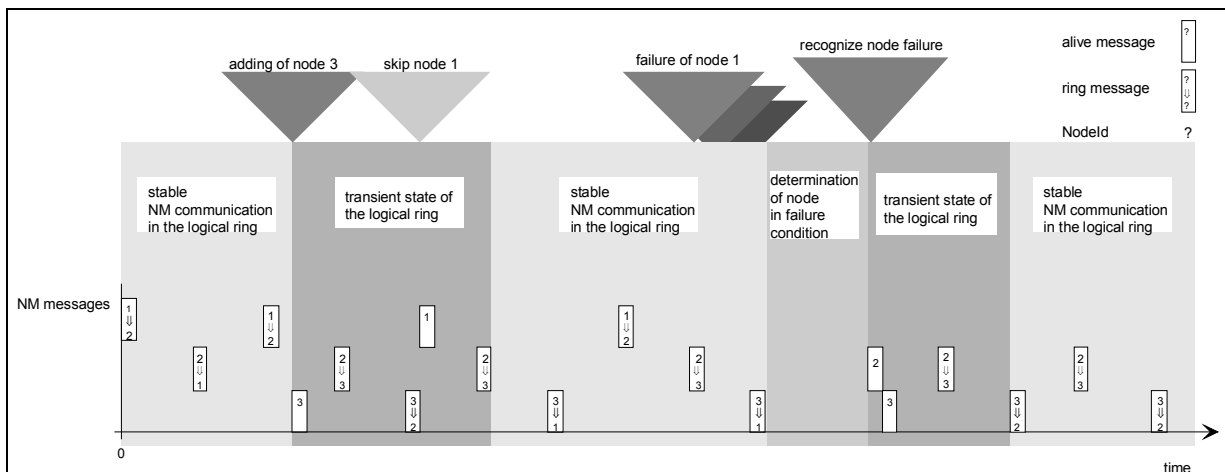

Figure 14 Regeneration principle of decentralized configuration management as a basis for NM communication in the logical ring

2.2.4.4. Particularities Regarding Implementation

The emitting of a message is not interruptible

During normal operation, a ring message must be transmitted or passed with a delay unless another ring message has been received during the delay.

Due to particularities of some asynchronous protocol implementations, this task cannot be executed directly in line with the verbal statement.

In view of node i , there is no way of preventing an external ring message being received which really prohibits the transmission of the node's own ring message between the decision to send the ring message of its own and the actual transmission.

This effect is only critical if the external ring message received is destined to node i . In this case, two ring messages can be maintained permanently, as exactly the same constellation may occur at the logical successor.

The figure below shows a constellation of ring messages which enables the simultaneous occurrence of two ring messages without specific measures.

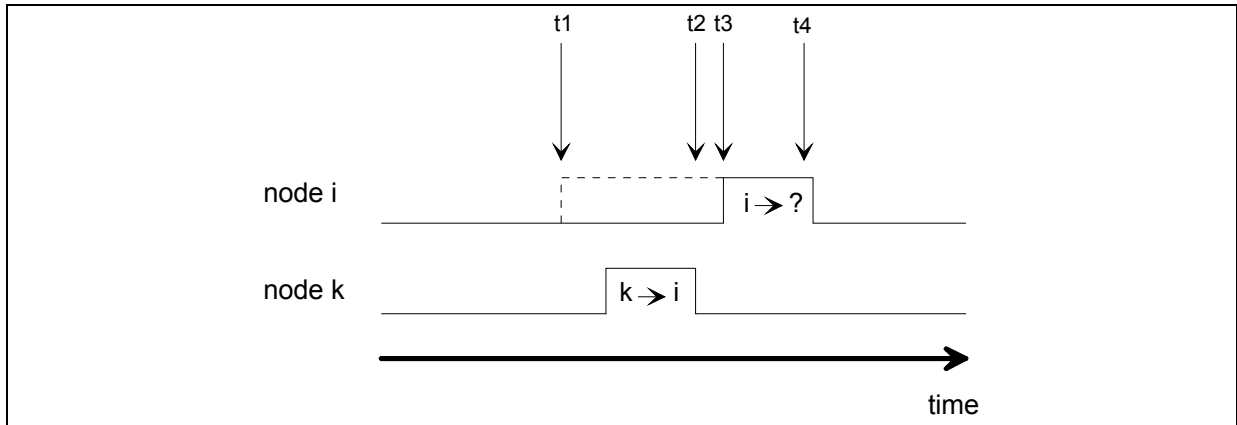
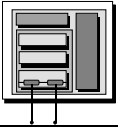

Figure 15 ring messages from the nodes i and k on an asynchronous bus

- t1 The timer T_{Typ} in node i has elapsed and the ring message of node i is released for transmission.
As the bus is busy, this ring message cannot be transferred.
- t2 Node i receives the respective ring message from node k.
- t3 The ring message of node i is transmitted to the bus.
- t4 The ring message of node i was transmitted to the bus successfully.

Node i would really pass the ring message received at t_2 with a delay of T_{Typ} . However in this case, it would have to terminate the ring message requested at t_1 which has not yet been emitted. This is not possible in most cases.

To avoid two simultaneous ring messages occurring at the same time, each node must ignore a ring message addressed to it between the moments t_1 and t_4 .

Timer Structure in the State "NMNormal"

The timers T_{Typ} and T_{Max} are set, reset and cancelled for supervision of the NM communication.

The applicability of alarm services `SetAlarm` and `CancelAlarm` is assumed (see also section *Requirements to OSEK Operating System*).

	T_{Typ}		T_{Max}	
	<code>SetAlarm</code>	<code>CancelAlarm</code>	<code>SetAlarm</code>	<code>CancelAlarm</code>
ring message received	-	✓	✓	✓
Addressed by ring message or source equal destination	✓		-	
ring message transmitted	-	✓ ¹⁾	✓	✓
Transition from NMReset to NMNormal	✓	-	-	-

Table 5 Timer actions in NMNormal, during various bus actions.
¹⁾ a duplicated ring is avoided (see text below)

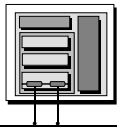

This application fulfils the bus-specific requirement to avoid several ring messages. The table shows the activities of the timers in NMNormal. Individual timer requests are terminated abnormally and/or set as required by the bus activities detected. In this context, ¹⁾ is of particular interest. Between the moment when the decision to pass the node's own ring message is made and the moment when it is actually transmitted, any additional request to pass the ring message must be ignored. So, if the request T_{Typ} is cancelled as a precautionary measure whenever its own ring message is transmitted, this task is accomplished with minimum effort.

Processing a timer request only necessitates triggering two actions in NMNormal. Timer T_{Typ} is responsible for passing the ring message, whereas timer T_{Max} monitors the cyclic occurrence of the ring messages; it serves to detect a general configuration error.

	T_{Typ} elapses	T_{Max} elapses
send ring message	✓	-
go to NMReset	-	✓

Table 6 Main actions which are triggered by an expired timer in NMNormal.

How two ring messages are prevented

The NM was specified on the base of a broadcast channel and a serial bus protocol. Therefore every node receives every NM message at nearly the same time. NM adjustments are overwritten by a received NM message - NM messages are handled with time priority.

One of the basic principals of the NM is the synonym between an elapsed T_{Typ} alarm and the emission of a regular ring message to a logical successor. The specified algorithms guarantee, that a running T_{Typ} alarm exists always in only one node inside the whole network. A received regular ring message re-triggers in the addressed node (destination of the message) the T_{Typ} alarm and cancels in all other nodes the T_{Typ} alarms.

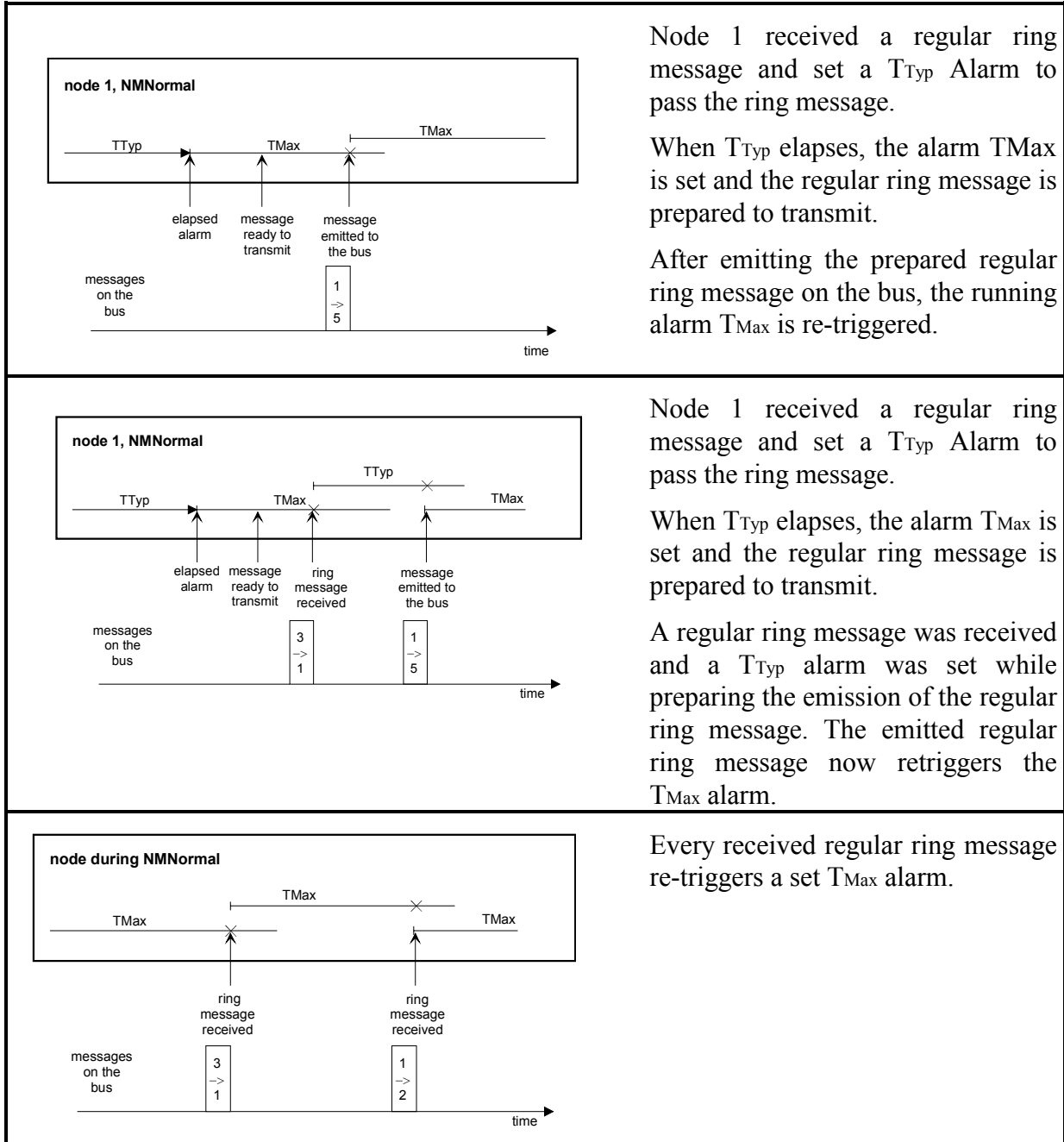
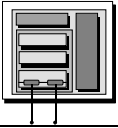

Node 1 received a regular ring message and set a T_{Typ} Alarm to pass the ring message.

When T_{Typ} elapses, the alarm T_{Max} is set and the regular ring message is prepared to transmit.

After emitting the prepared regular ring message on the bus, the running alarm T_{Max} is re-triggered.

Node 1 received a regular ring message and set a T_{Typ} Alarm to pass the ring message.

When T_{Typ} elapses, the alarm T_{Max} is set and the regular ring message is prepared to transmit.

A regular ring message was received and a T_{Typ} alarm was set while preparing the emission of the regular ring message. The emitted regular ring message now re-triggers the T_{Max} alarm.

Every received regular ring message re-triggers a set T_{Max} alarm.

Figure 16 Examples for mechanisms to synchronize the NM alarms and their effects on the behavior of the NM

- top Passing of a ring message during the fixed state of the logical ring.
- middle Passing of a ring message during the dynamic state of the logical ring - mechanism to avoid two ring messages.
- bottom Monitoring of ring messages during the fixed state of the logical ring.

2.2.5. Example: Skipped in the logical ring

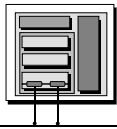

Every node is able to define a temporary logical ring in case of the reception of a ring message to any node in the network. The ring is given by the identifications of the receiver node, the source node of the message and the addressed destination node.

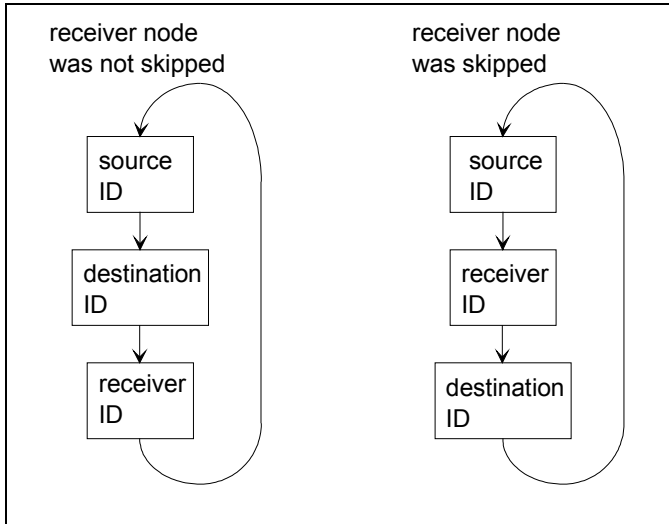

Figure 17

temporary logical ring for the test, whether the receiver node has been skipped or not

- Source ID** Transmitter of the ring message
- Destination ID** addressed node
- Receiver ID** Receiver of the ring message

By arranging the node identifications in a numerical order, one will get:

SDR	(Source→)	<	(→Destination)	<	(Receiver)	✓
RSD	(Receiver)	<	(Source →)	<	(→Destination)	✓
DRS	(→Destination)	<	(Receiver)	<	(Source →)	✓
DSR	(→Destination)	<	(Source →)	<	(Receiver)	skipped
RDS	(Receiver)	<	(→Destination)	<	(Source →)	skipped
SRD	(Source →)	<	(Receiver)	<	(→Destination)	skipped

The receiver node has been skipped in the lower three combinations. An alive message has to be emitted asynchronously by the receiver node.

Note

It is not always necessary to look for skipping at the reception of a ring message.

- S=D The source node does not know anything about other nodes.
- D=R The receiver node of the ring message itself was addressed.
- S=R The receiver node was the sender of the message

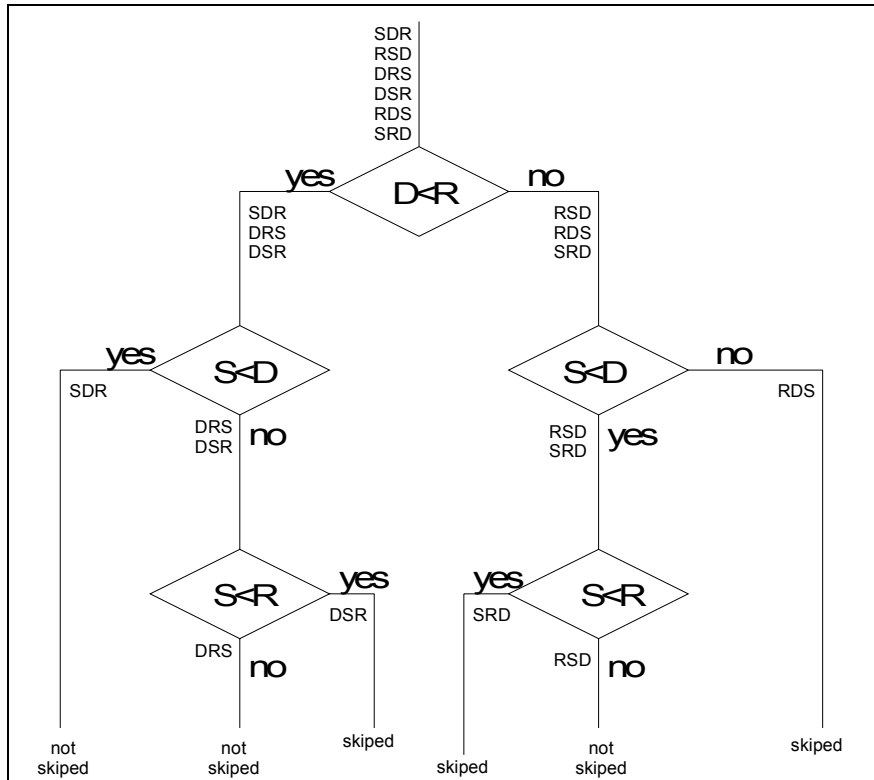
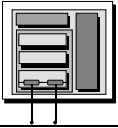

Figure 18

IF-conditions for the test “Was a receiver node skipped by a ring message on the logical ring?”

S node identification of the source

R node identification of the receiver

D node identification of the destination

From two to three IF conditions are necessary.

2.2.6. Example: Logical Successor

The source node of any received NM message could turn to the logical successor of the received node. To reach a decision on whether the source node is the new logical successor of the receiver node, the receiver node has to look to the receiver identification, the source identification and to the identification of the logical successor.

SLR	(Source)	<	(Log. successor)	<	(Receiver)	new logical successor
RSL	(Receiver)	<	(Source)	<	(Log. successor)	new logical successor
LRS	(Log. successor)	<	(Receiver)	<	(Source)	new logical successor
LSR	(Log. successor)	<	(Source)	<	(Receiver)	✓
RLS	(Receiver)	<	(Log. successor)	<	(Source)	✓
SRL	(Source)	<	(Receiver)	<	(Log. successor)	✓

The state NMReset initializes the system-related basic configuration. Therefore the values L (Log. successor identification) and R (Receiver identification) are equal. The algorithm has to be initialized: the source of the first received NM message will be the logical successor.

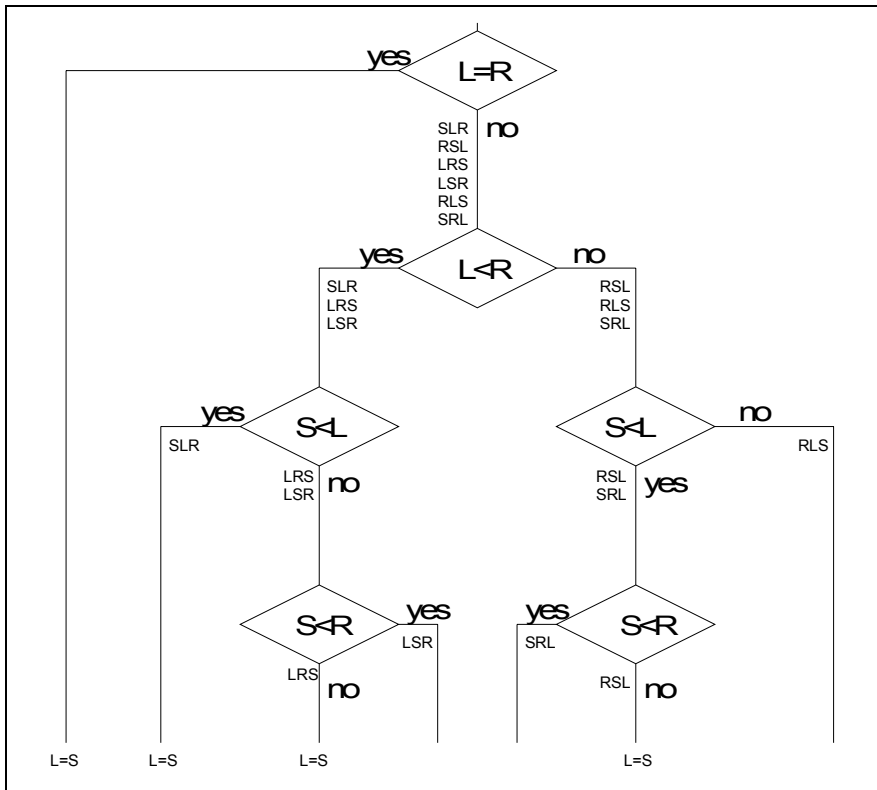
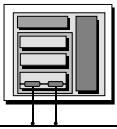

Figure 19

IF conditions to determine a logical successor

S node identification of the source

R node identification of the receiver

L node identification of the logical successor in the receiver node

From three to four IF conditions are necessary.

Note

Of course it is possible to determine the logical successor from the stored present configuration when a ring message has to be emitted.

2.2.7. Operating Mode

2.2.7.1. NMActive - NMPassive

In heterogeneous networks, individual nodes can suspend their network communication due to their specific requirements.

Each node owns a *silent mark* which can be set and reset by the application.

- silent mark set NMPassive desired = "1"
- silent mark cleared NMActive desired = "0"

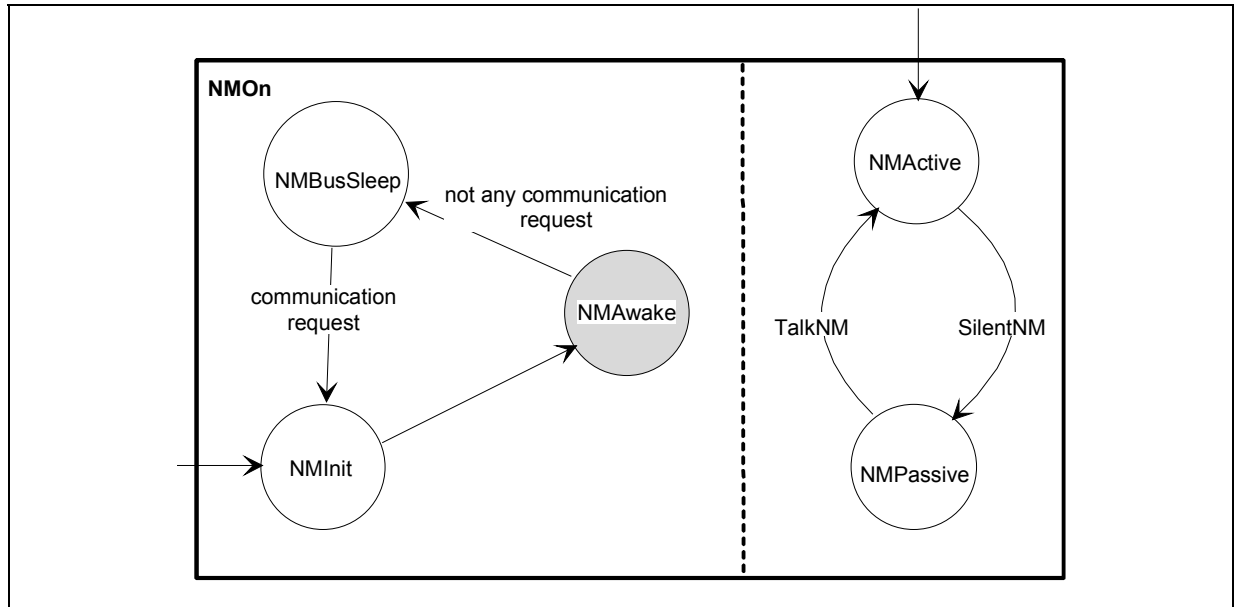
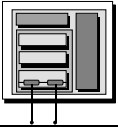

Figure 20 Toggling between NMAwake and NMPassive

2.2.7.2. NMBusSleep - NMAwake

The NM controls the access to the communication media on demand of the application. If the application in all nodes does not require the communication media, then the NM changes to the state NMBusSleep.

Principle for Transition into BusSleep Mode

Each node owns a sleep mark, which can be set and cleared by the application.

Service	Description	sleep mark
GotoMode(BusSleep)	NMBusSleep desired	set
GotoMode(Awake)	NMBusSleep not desired	cleared

Table 7 Services to change between the states NMBusSleep and NMAwake.

The NM maps this sleep mark (e.g. represented by a sleep bit) into each ring message (→ bit sleep.ind). If a set bit sleep.ind is transmitted, the NM internally changes to the state *NM~PrepBusSleep* (~: Normal or LimpHome).

When the sleep mark is set NM prepares for notified and network wide confirmed sleep mode.

The request for global NMBusSleep is set in a ring message. At each node participating in the logical ring this request for global sleep must be confirmed. The sleep mode initiating node must wait for network-wide confirmation of his request.

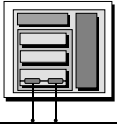

If the NM message has completely looped in the logical ring then the request is confirmed by a ring message with a set bit sleep.ack. The signaling specified by InitIndDeltaStatus is carried out and the transition is performed after a global delay TWaitBusSleep. After the successful transmission of the ring message with a set bit sleep.ack, there can still be user messages in the transmit queues. Nodes in the state LimpHome are transmitting limp-home messages delayed by TError. Several limp-home messages can be received in this time period thus a transition in the state NMBusSleep is possible without problems.

If the NM message has completely looped in the logical ring and the request is not confirmed, a NM message with different content is received or a NM message did not loop completely, the signalling specified by InitIndDeltaStatus cannot be carried out.

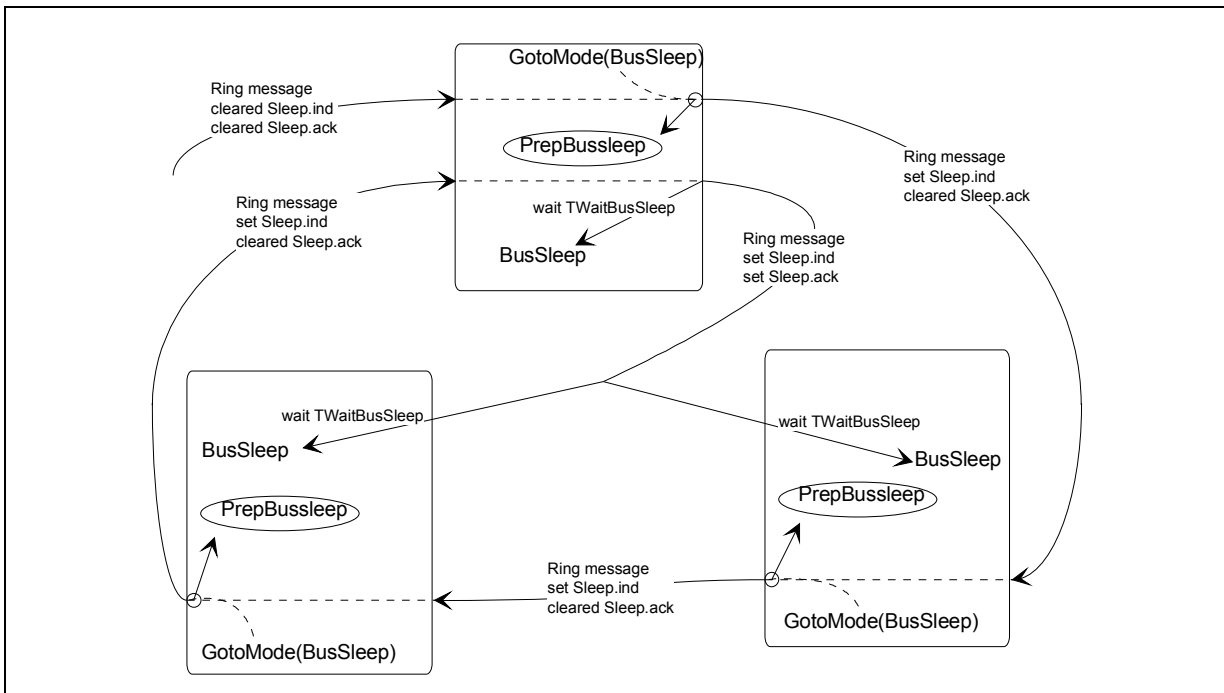

Figure 21 Algorithm of the transition: NMNormal → NMBusSleep

Note:

All nodes are ready to change over into NMBusSleep only if the signaling specified by InitIndDeltaStatus is carried out.

Up to that moment, application and NM must operate in its normal mode (i.e. NMNormal). The application still continues with its communication in the network, thus preventing error messages by the asynchronous transition of the nodes into NMBusSleep.

For transition into *network-wide sleep mode* the following cases are dealt with differently:

- transition from NMNormal into NMBusSleep
- transition form NMLimpHome into NMBusSleep

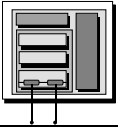

Transition from NMNormal into Network-wide BusSleep Mode

The NM is informed about the mode requested by the local function GotoMode(BusSleep). The figures below show the respective definitions.

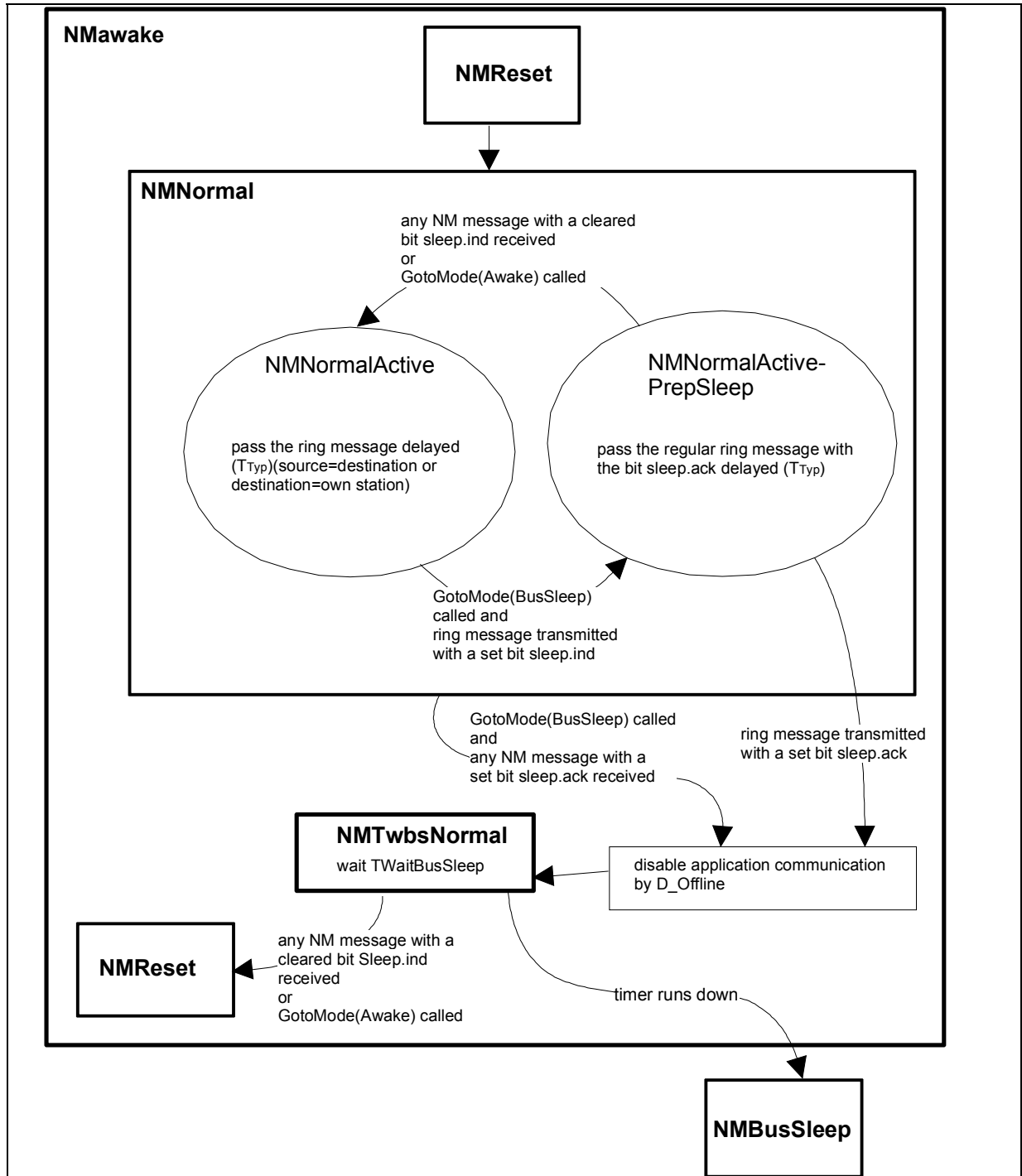
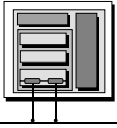

Figure 22 Algorithm for transition NMNormal → NMBusSleep



Transition from NMLimpHome into network wide BusSleep Mode

The function GotoMode(BusSleep) can also be called while NM operates in the mode NMLimpHome. The figure below shows the respective definitions.

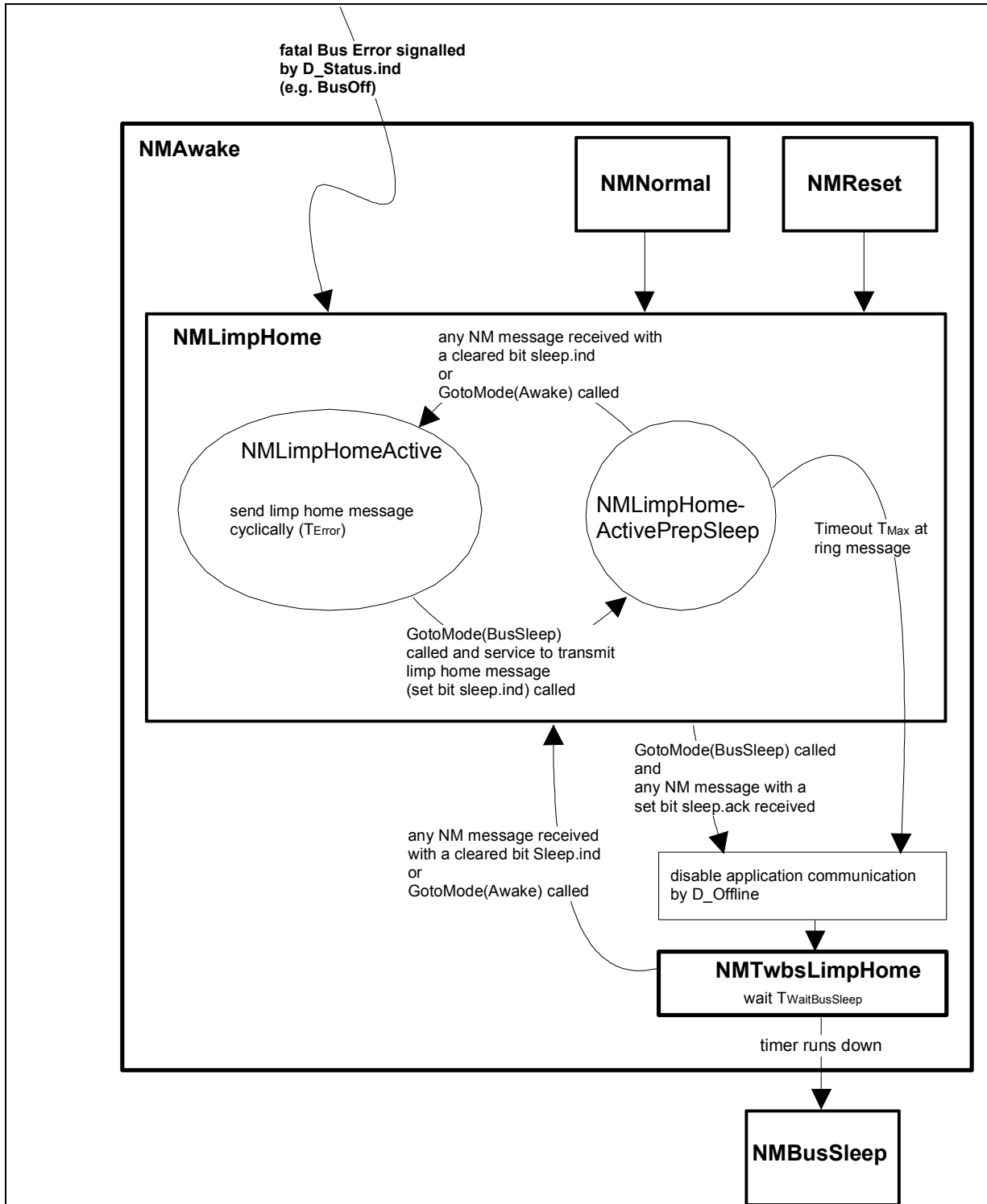
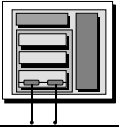

Figure 23 Algorithm for transition NMLimpHome → NMBusSleep



Transition from Network-wide BusSleep Mode to NMAwake

The state NMBusSleep is left if the service GotoMode(Awake) is called or if any NM message is received, i.e. a communication request exists.

2.2.8. Fusion of Configuration Management and Operating Modes

2.2.8.1. State Diagrams

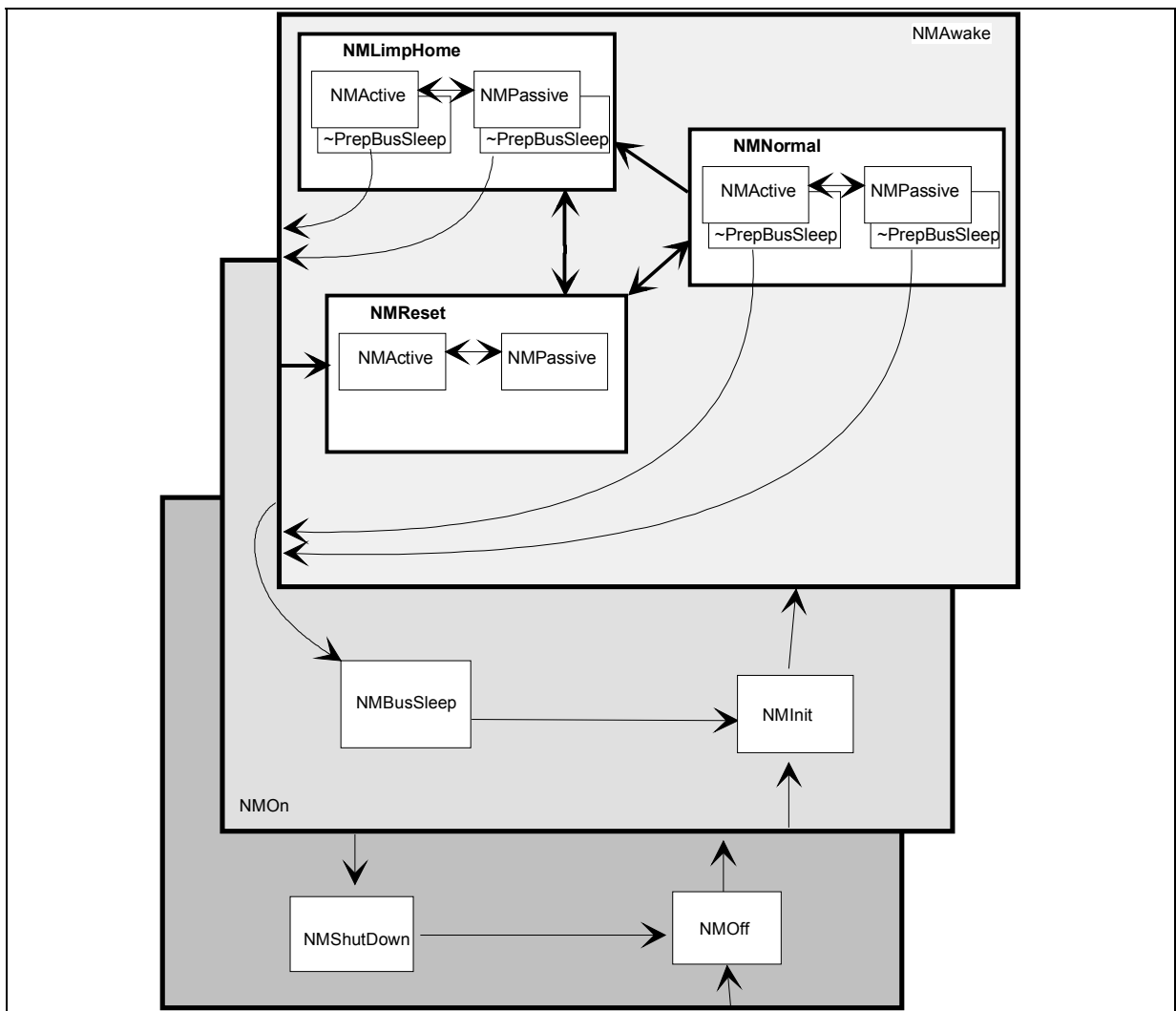

Figure 24 Simplified state transition diagram of the direct NM configuration management and operation modes are summarized

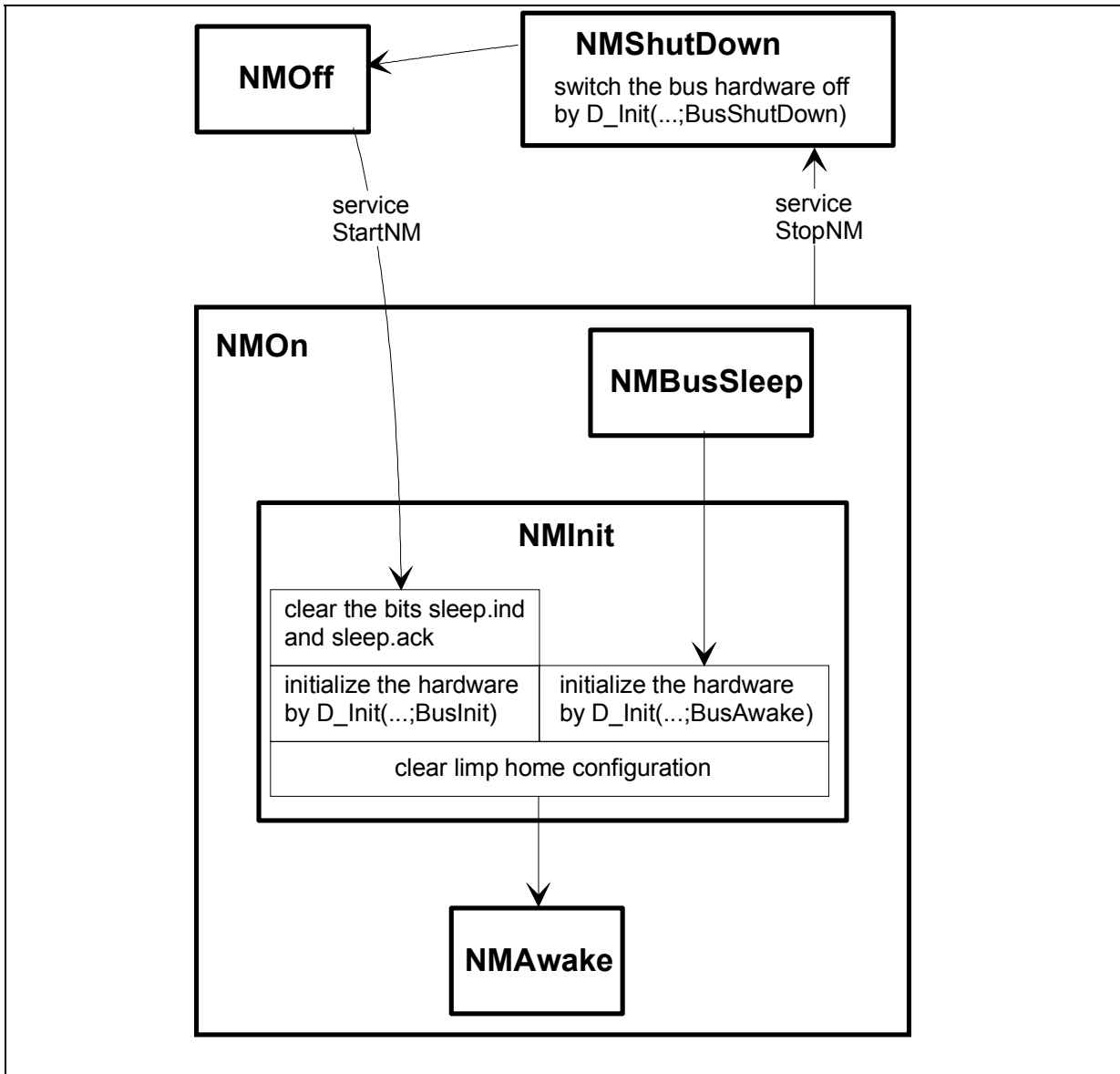
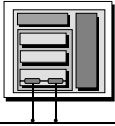

Figure 25 State transition diagram of NMIInit

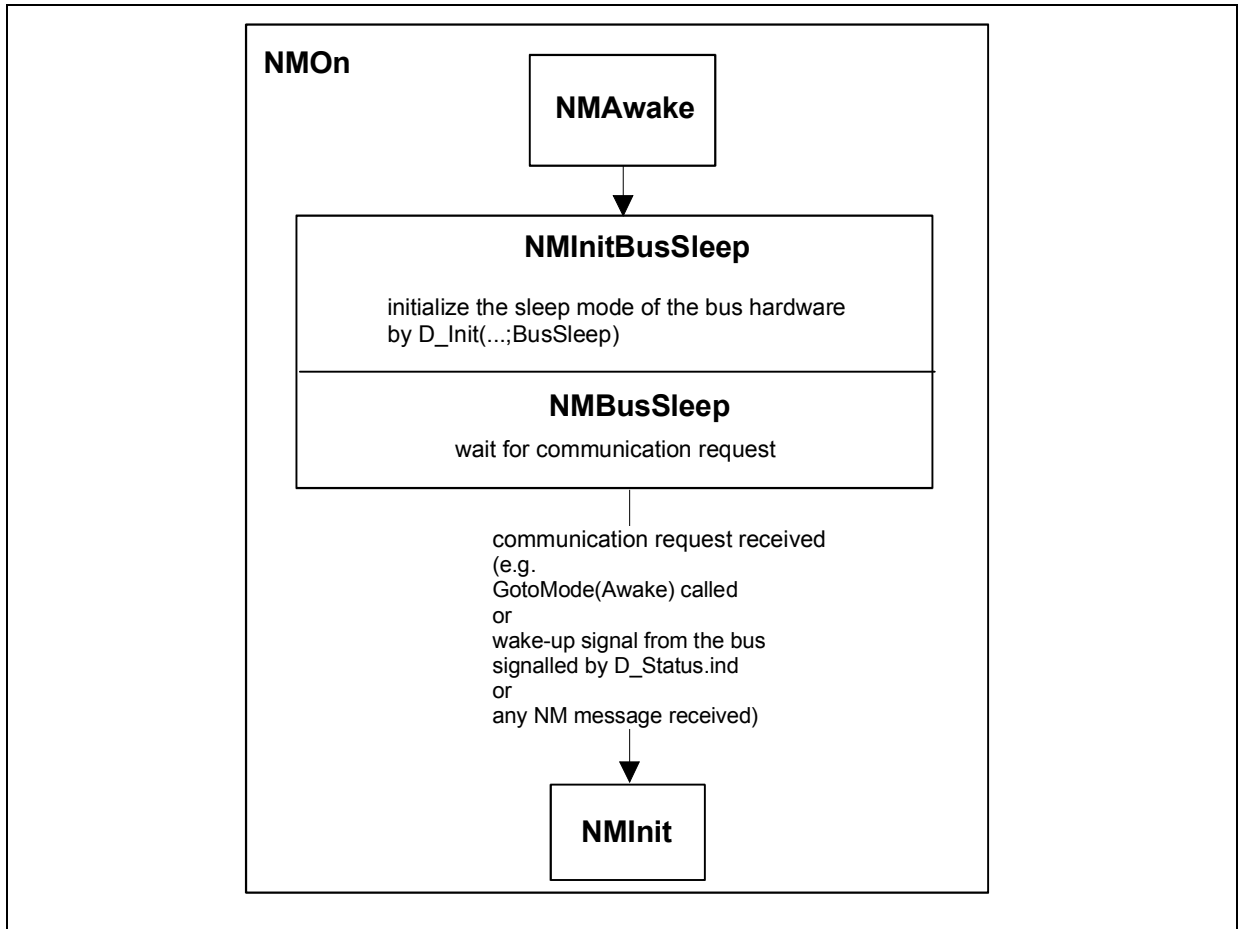
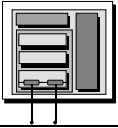

Figure 26 State transition diagram of NMBusSleep

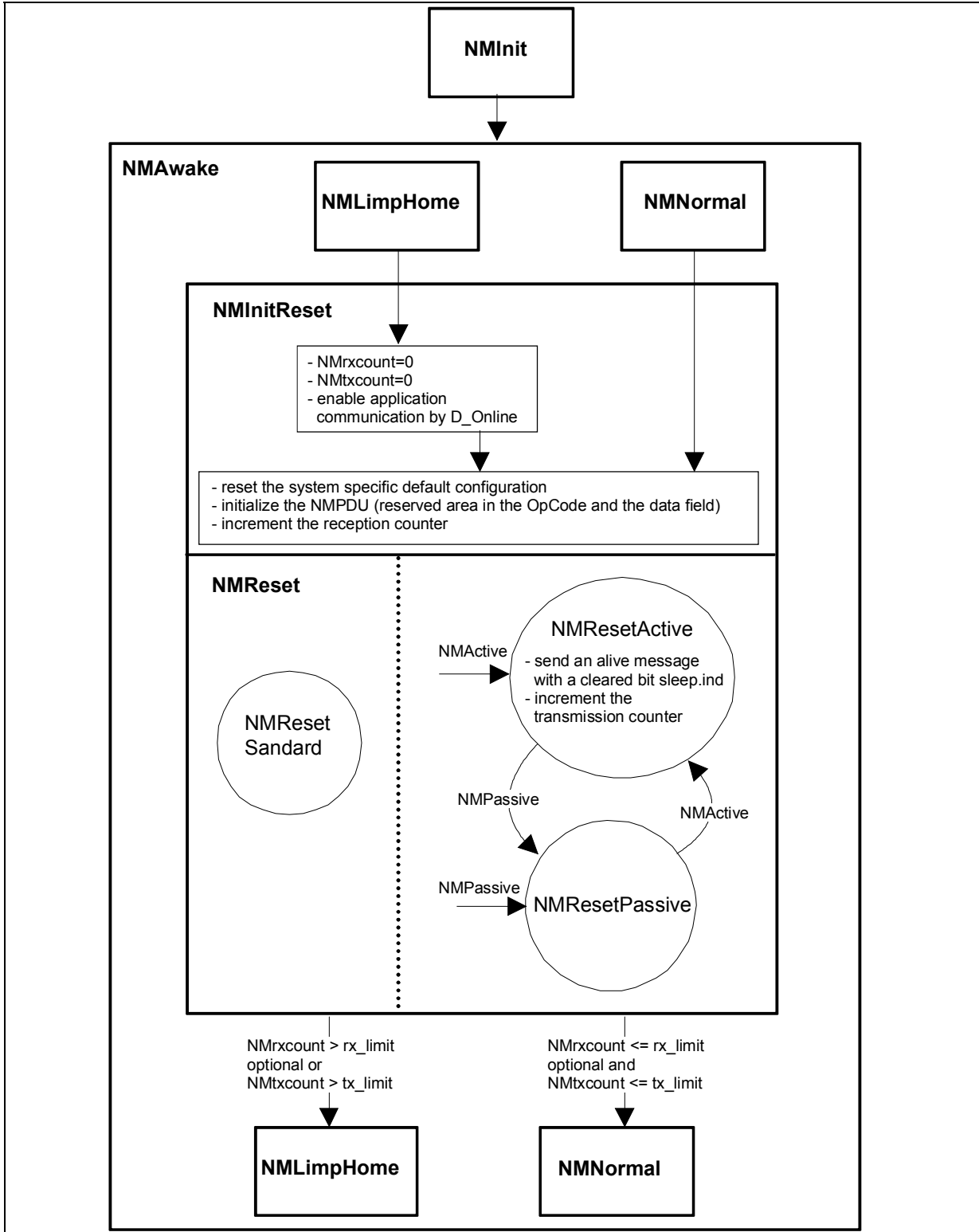
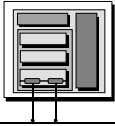

Figure 27 State transition diagram of NMReset

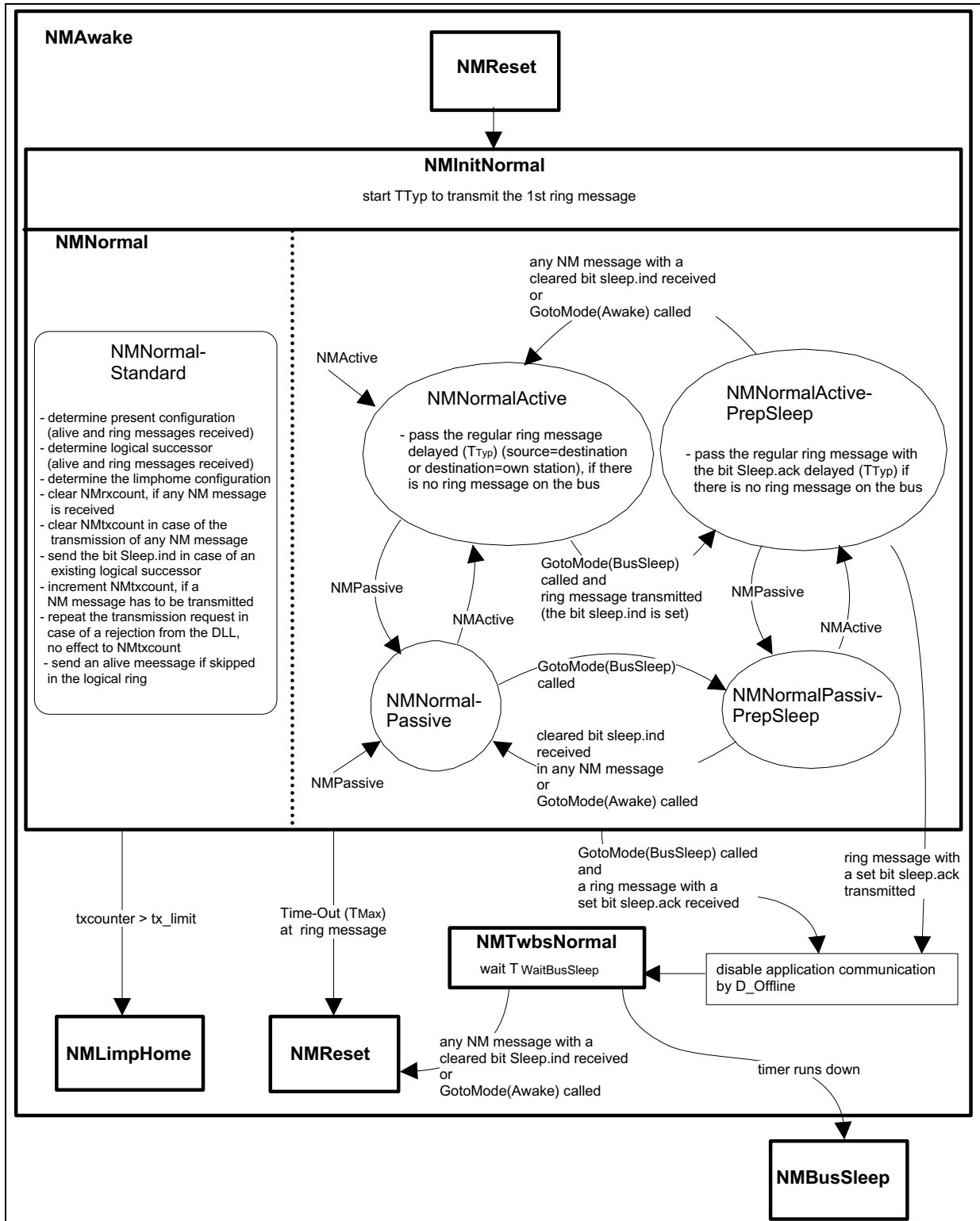
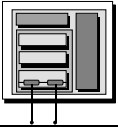

Figure 28 State transition diagram of NMNormal

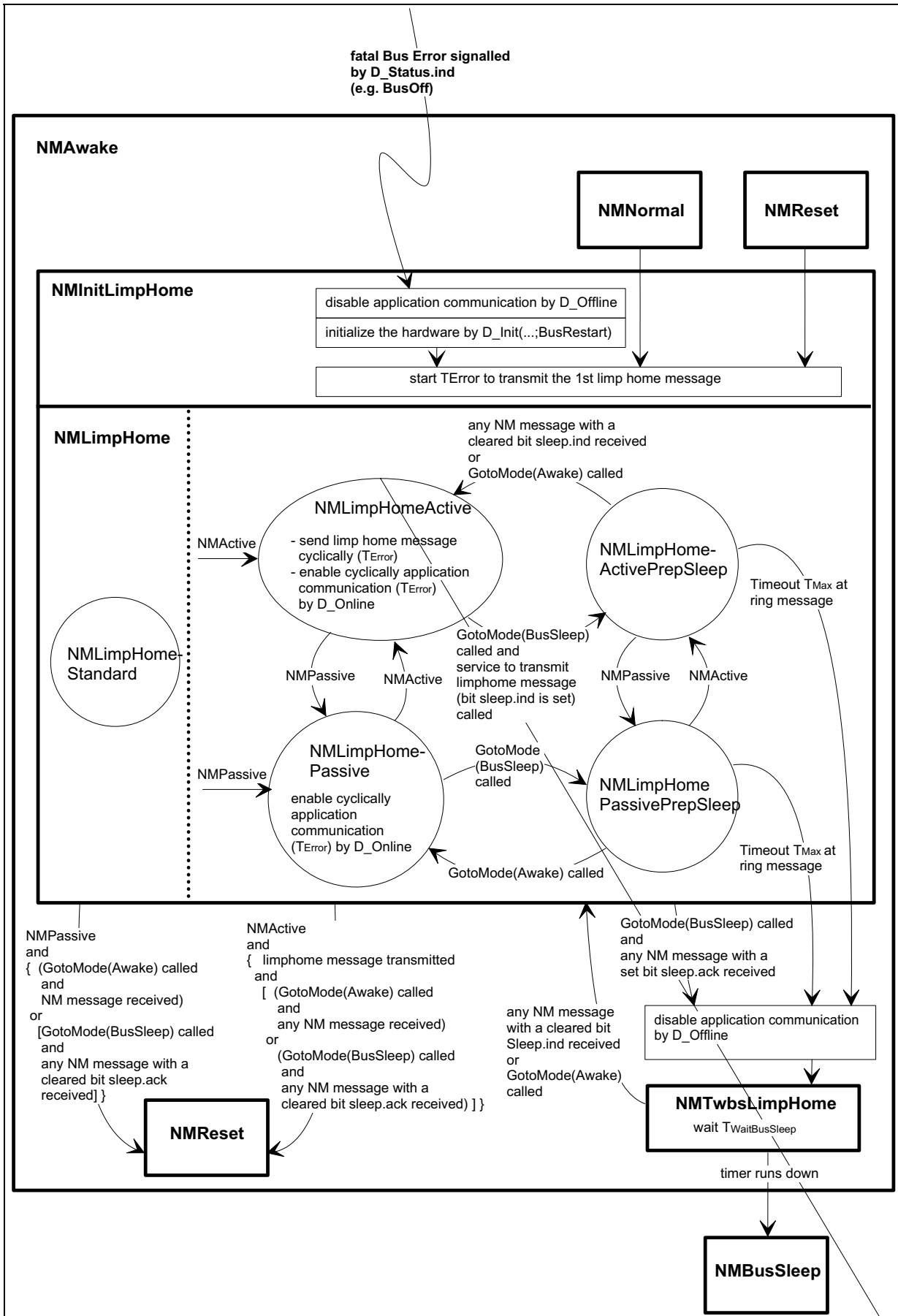
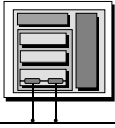
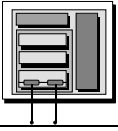

Figure 29 State transition diagram of NMLimpHome



2.2.8.2. SDL Diagrams

The specified behavior is represented by the state transition diagrams. This chapter describes a proposed SDL realization.

Hints

The following abbreviations are used:

sleep.ind	the bit "sleep.ind" from the actual received or transmitted NM message
sleep.ack	the bit "sleep.ack" from the actual received or transmitted NM message
networkstatus.bussleep	the bit of the network status "service GotoMode(Awake) called" or "service GoToMode(BusSleep) called"

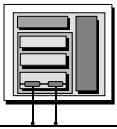

Start-up of the network

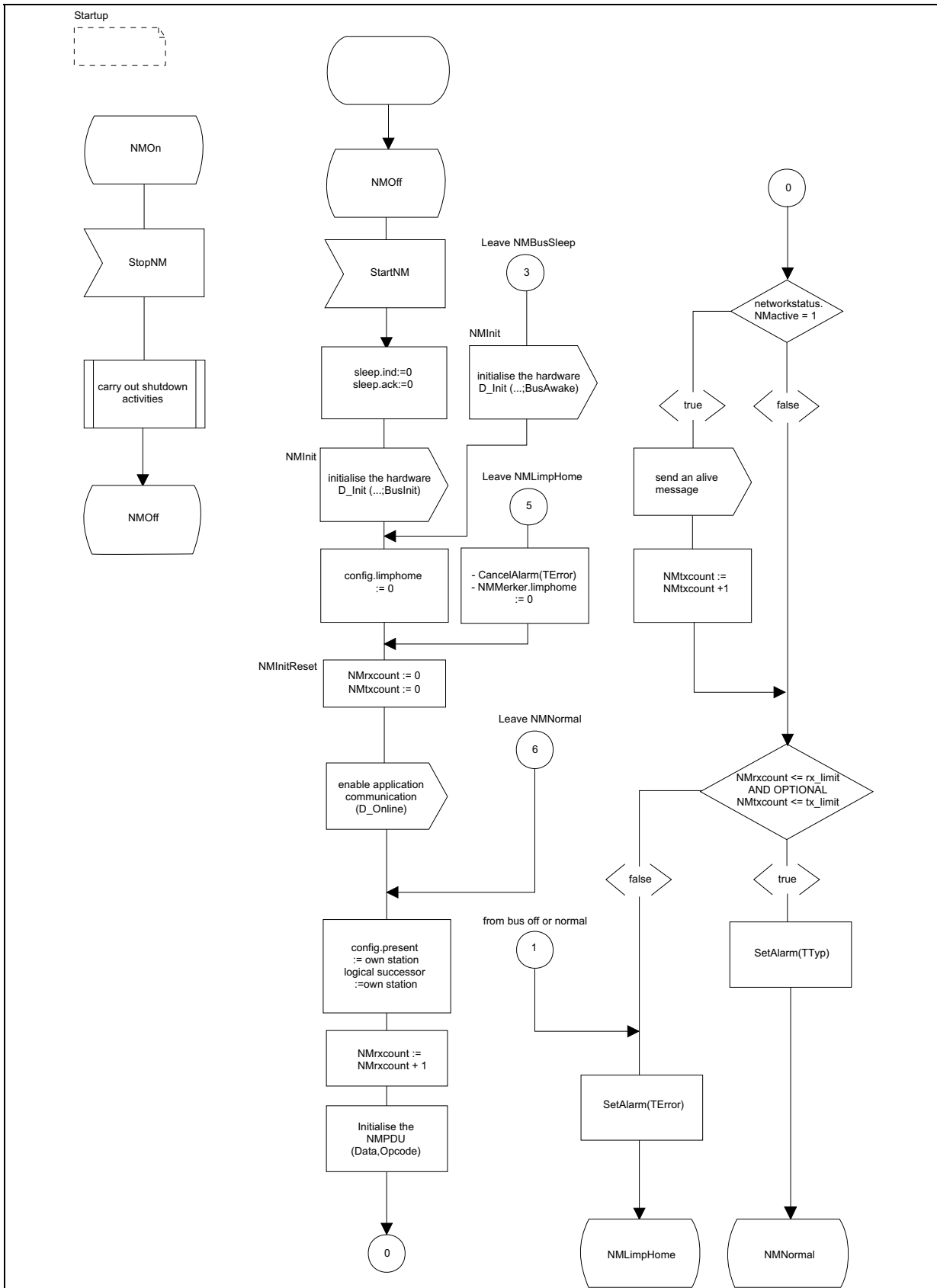
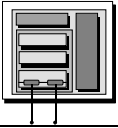

Figure 30 Start-up of the network



State NMOOn

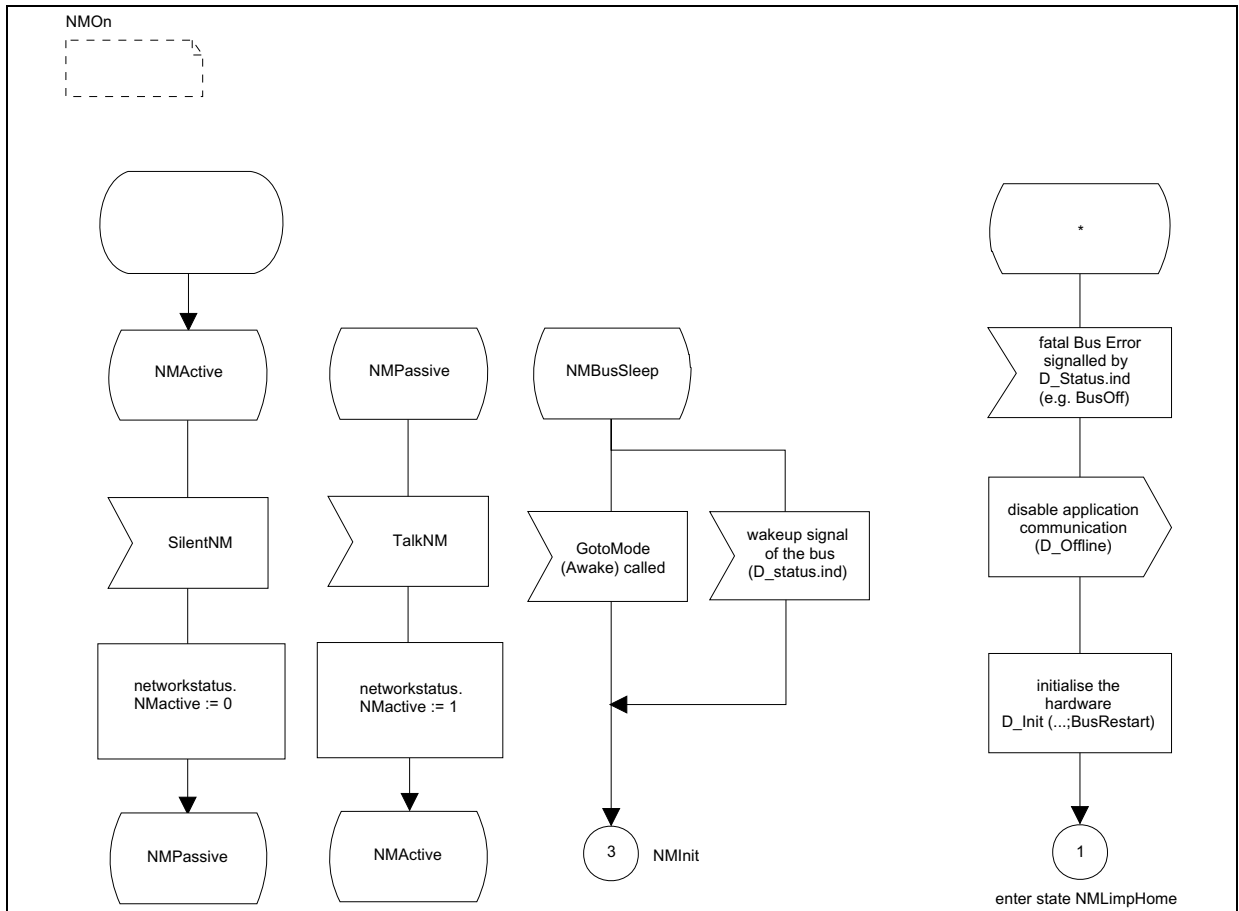
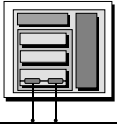

Figure 31 Transitions between NMActive and NMPassive, wake up from NMBusSleep, and bus off event.



State NMNormal

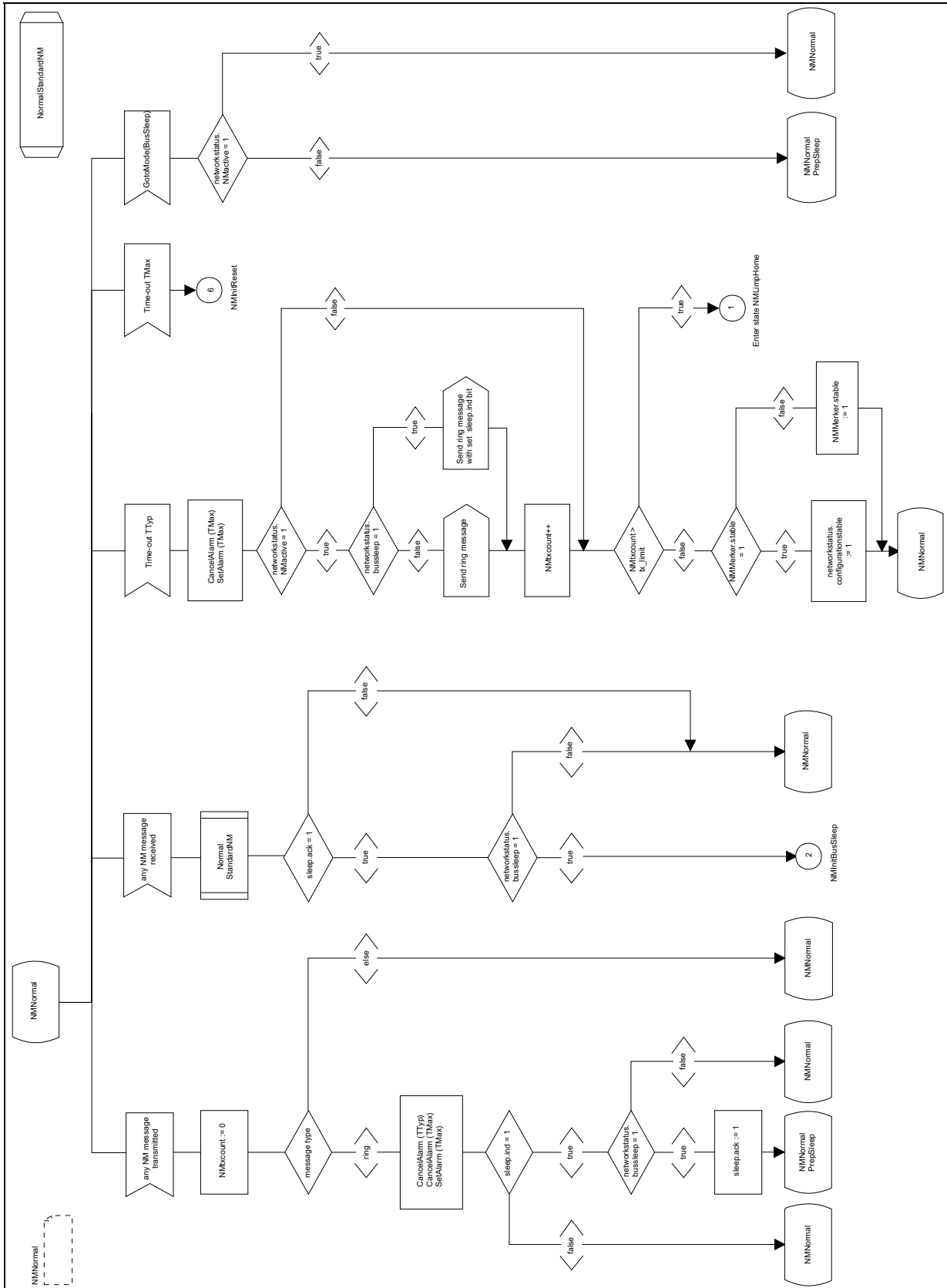
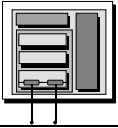

Figure 32 Actions during the state NMNormal and transitions to leave the state NMNormal



State *NMNormalPrepSleep*

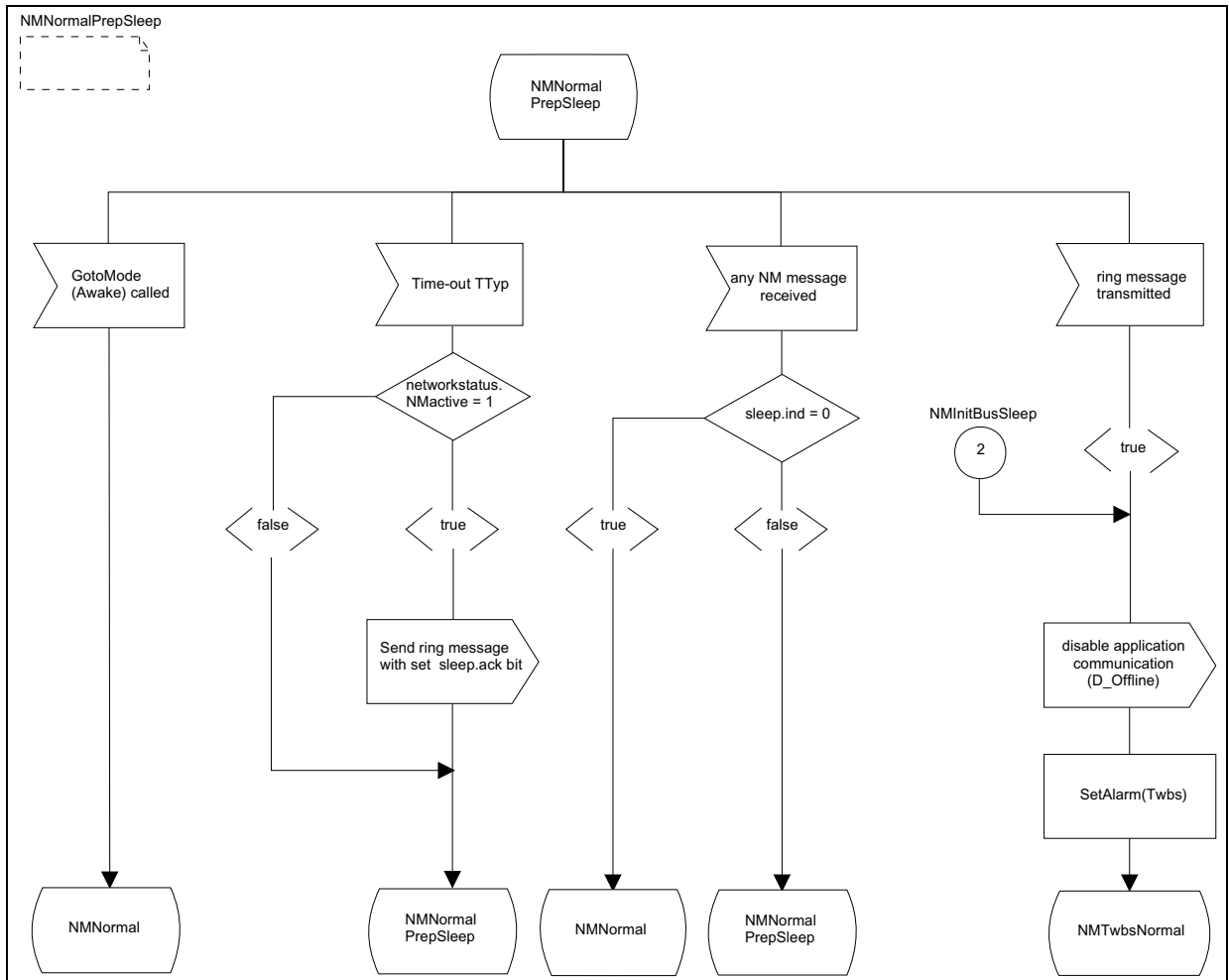
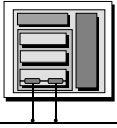

Figure 33 Actions during the state *NMNormalPrepSleep* and transitions to leave the state *NMNormalPrepSleep*



State *NMTwbsNormal*

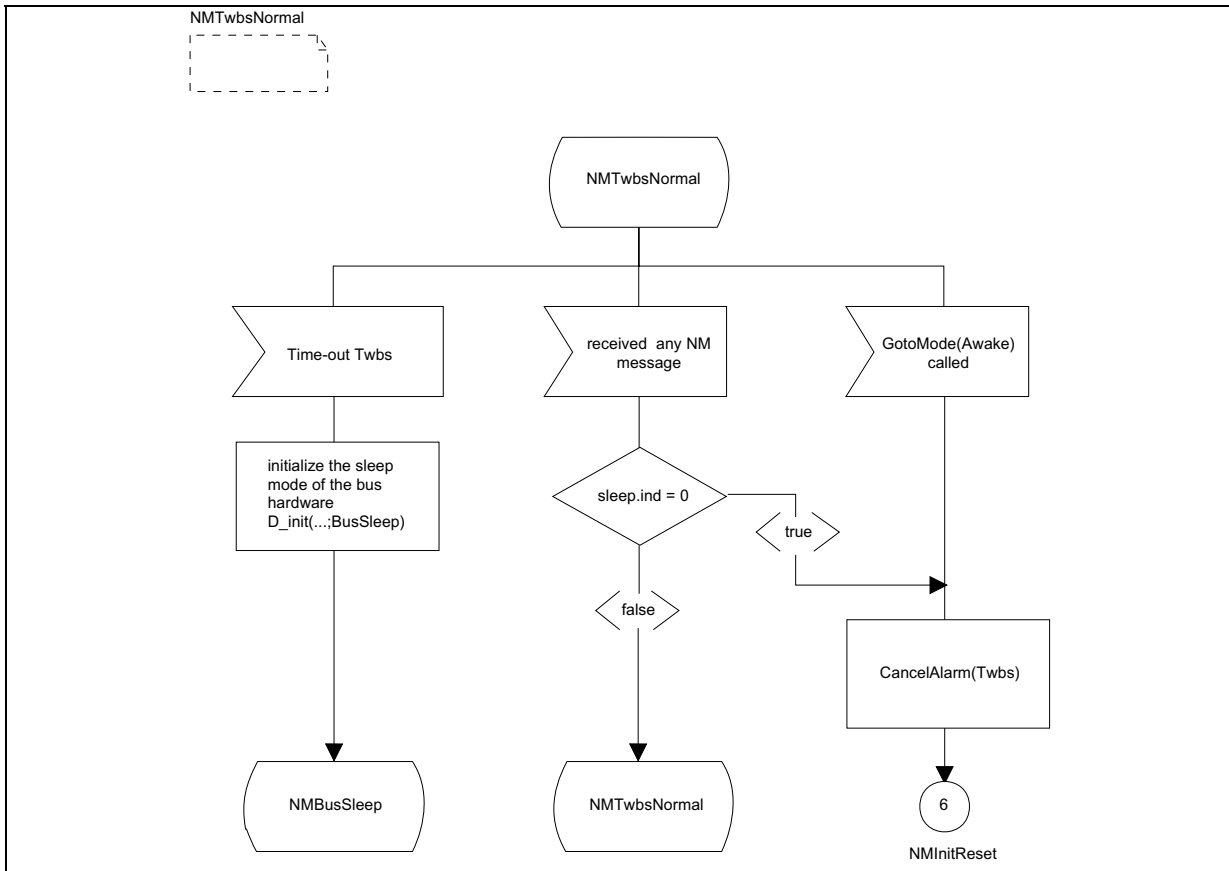
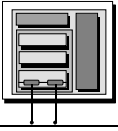

Figure 34 Transitions to leave state *NMTwbsNormal*



State NMLimpHome

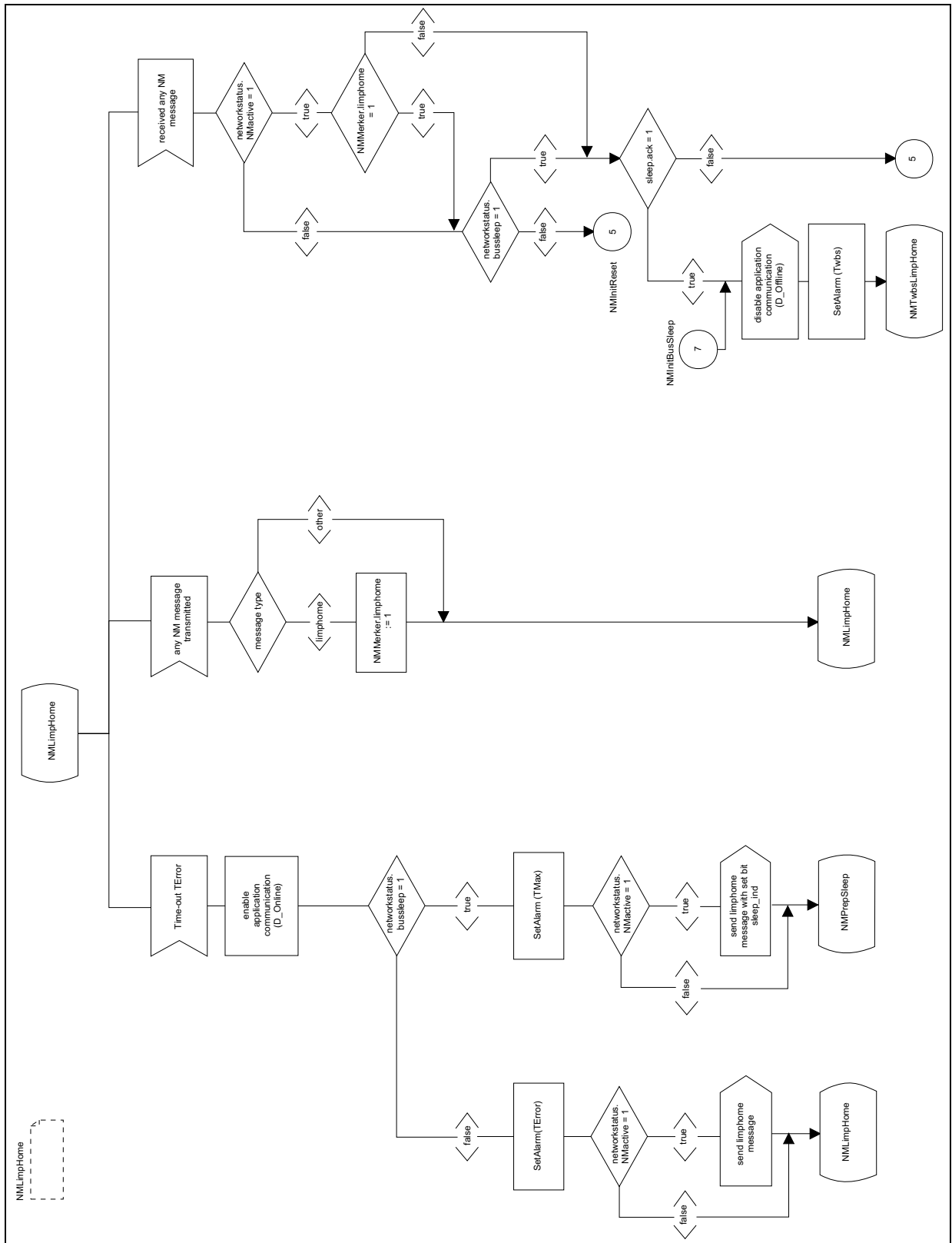
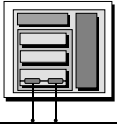

Figure 35 Actions during the state NMLimpHome and transitions to leave the state NMLimpHome



State NMLimpHomePrepSleep

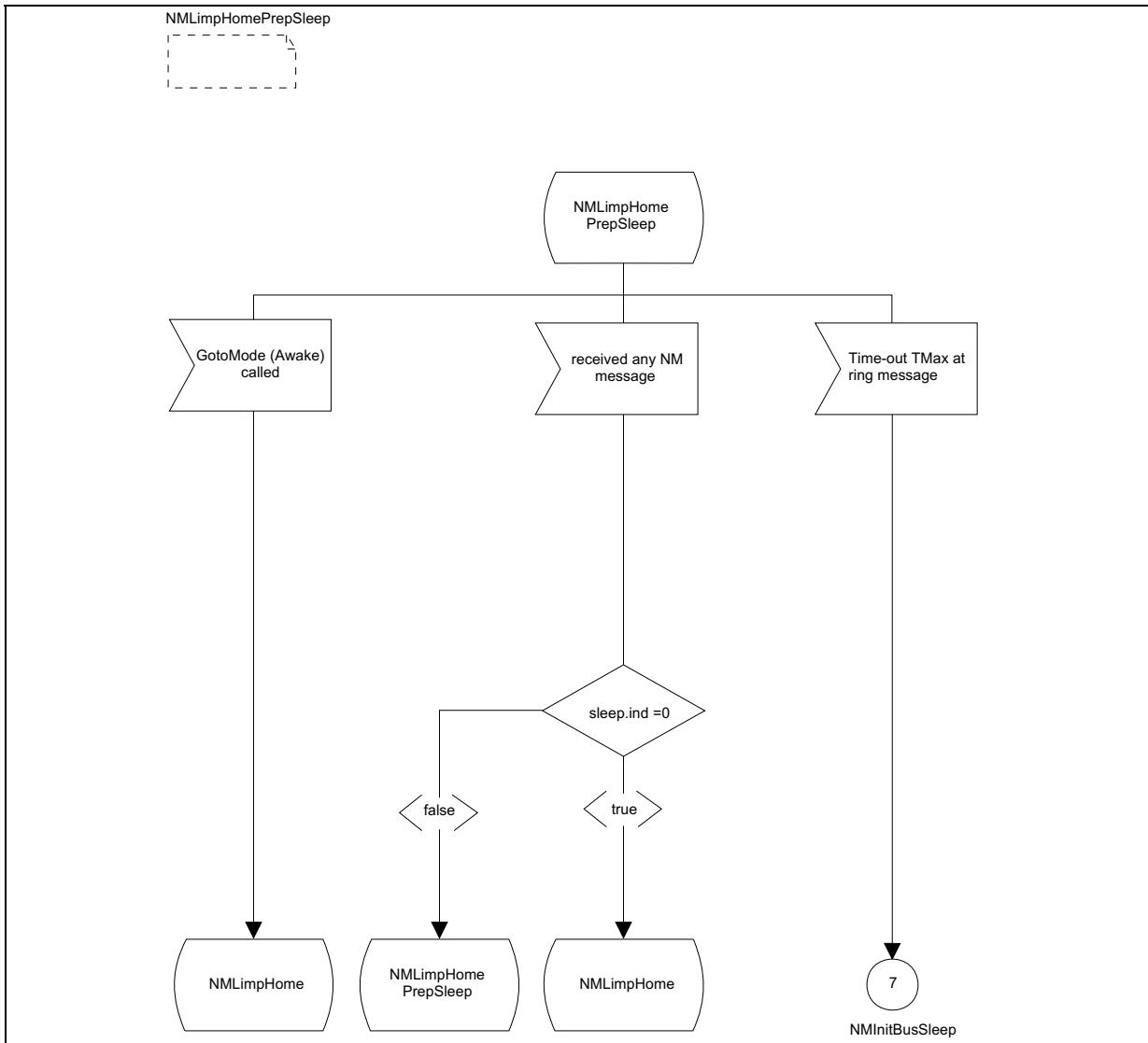
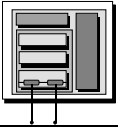

Figure 36 NMLimpHomePrepSleep



State *NMTwbsLimpHome*

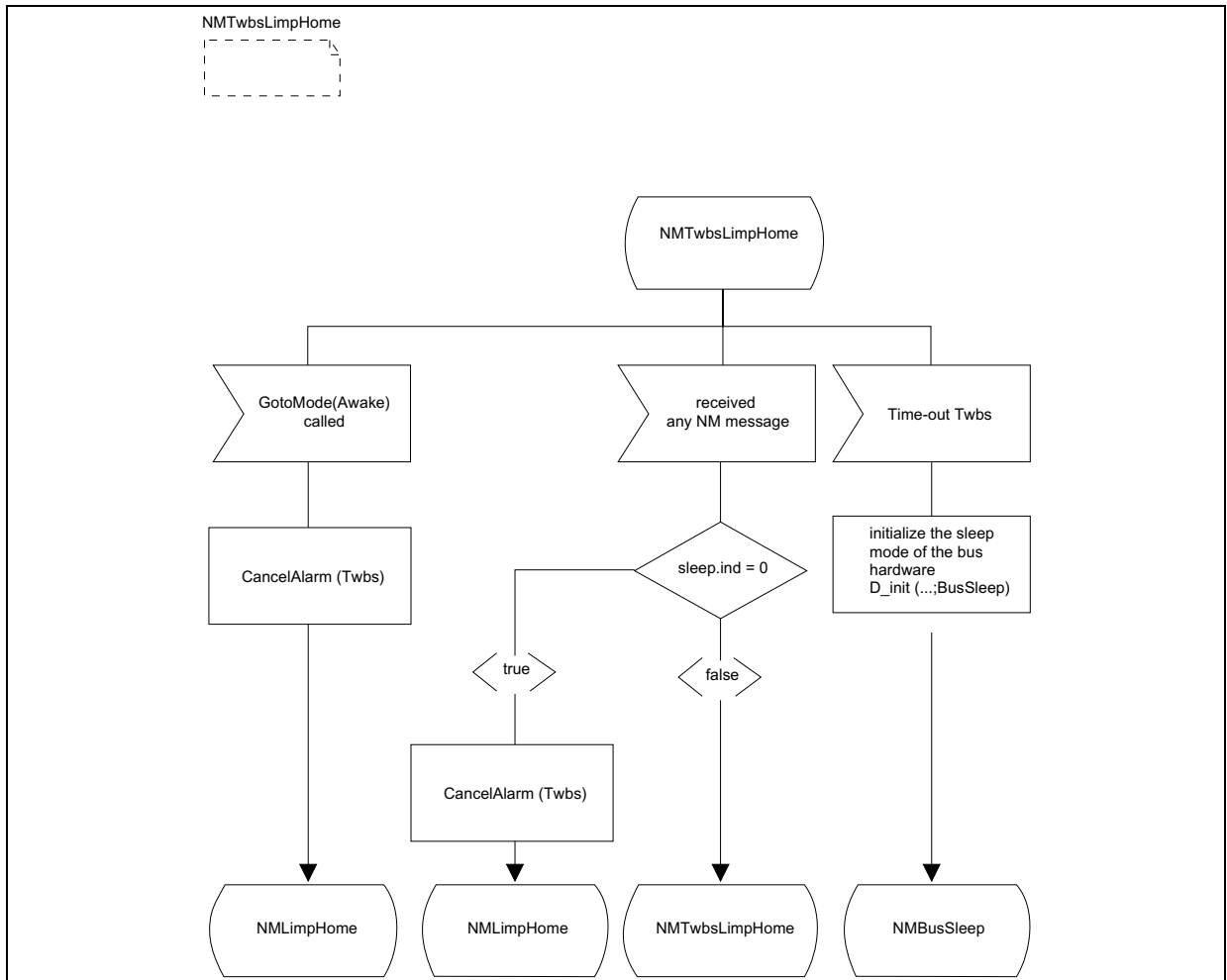
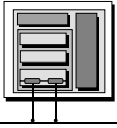

Figure 37 Transitions to leave the state *NMTwbsLimpHome*



Procedure NormalStandardNM

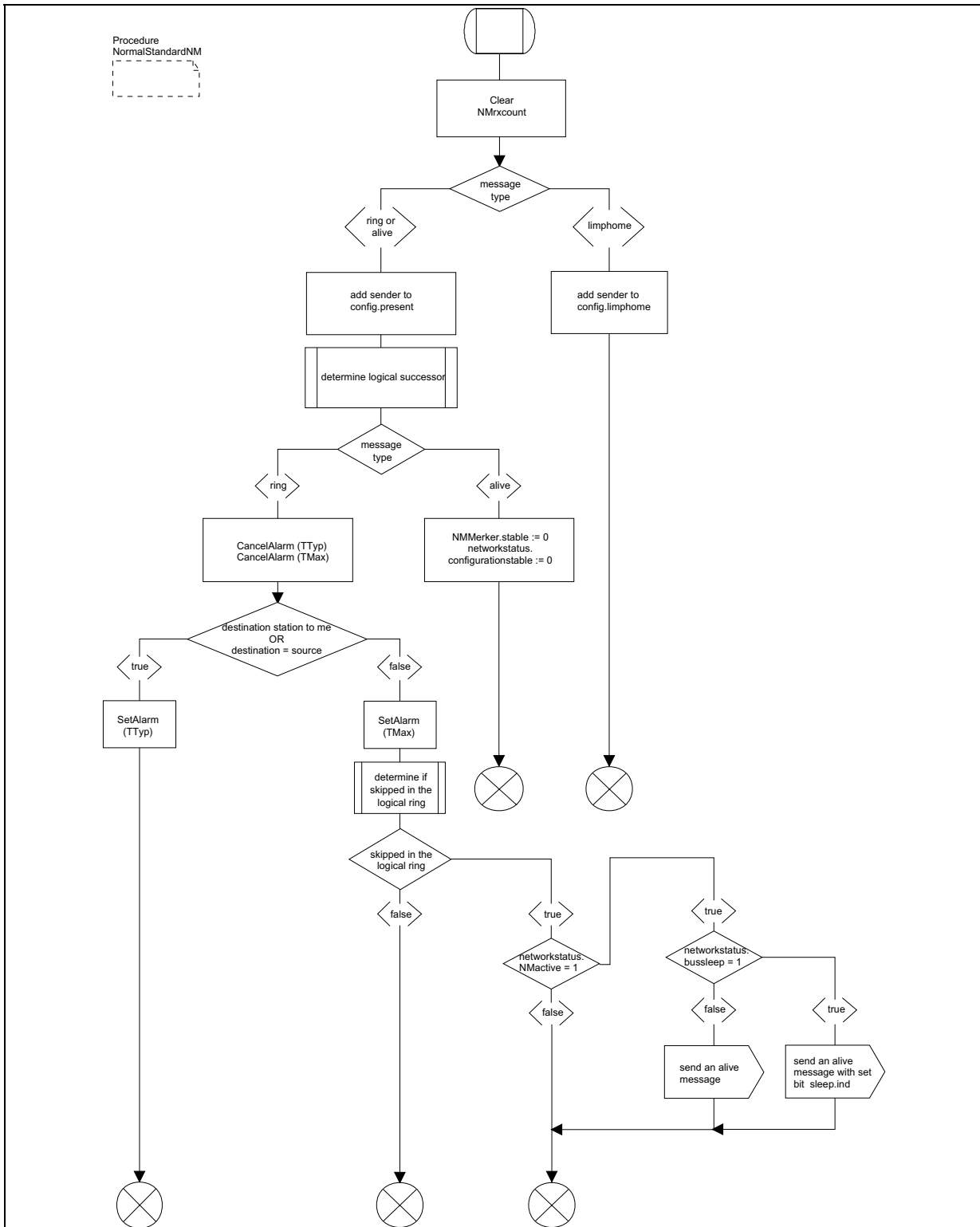
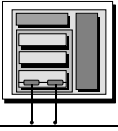

Figure 38 Actions during NMNormalStandard



DLL transmit rejection, GotoMode(Awake) and GotoMode(BusSleep)

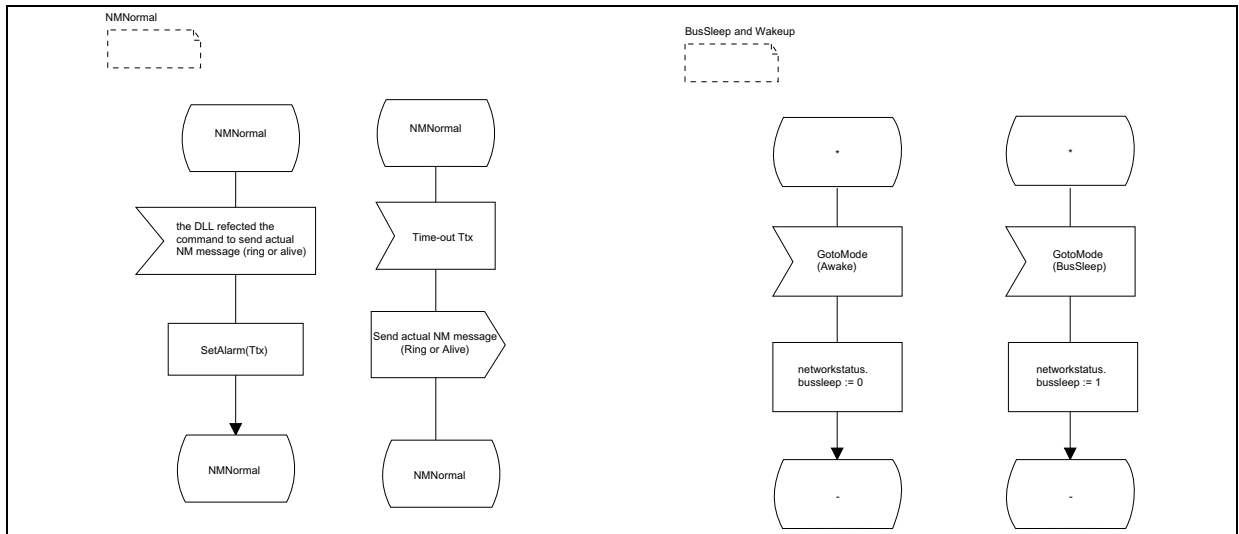
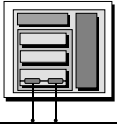

Figure 39 DLL transmit rejection and GotoMode(Awake/BusSleep)



Indication of Ring Data, Configuration and Status

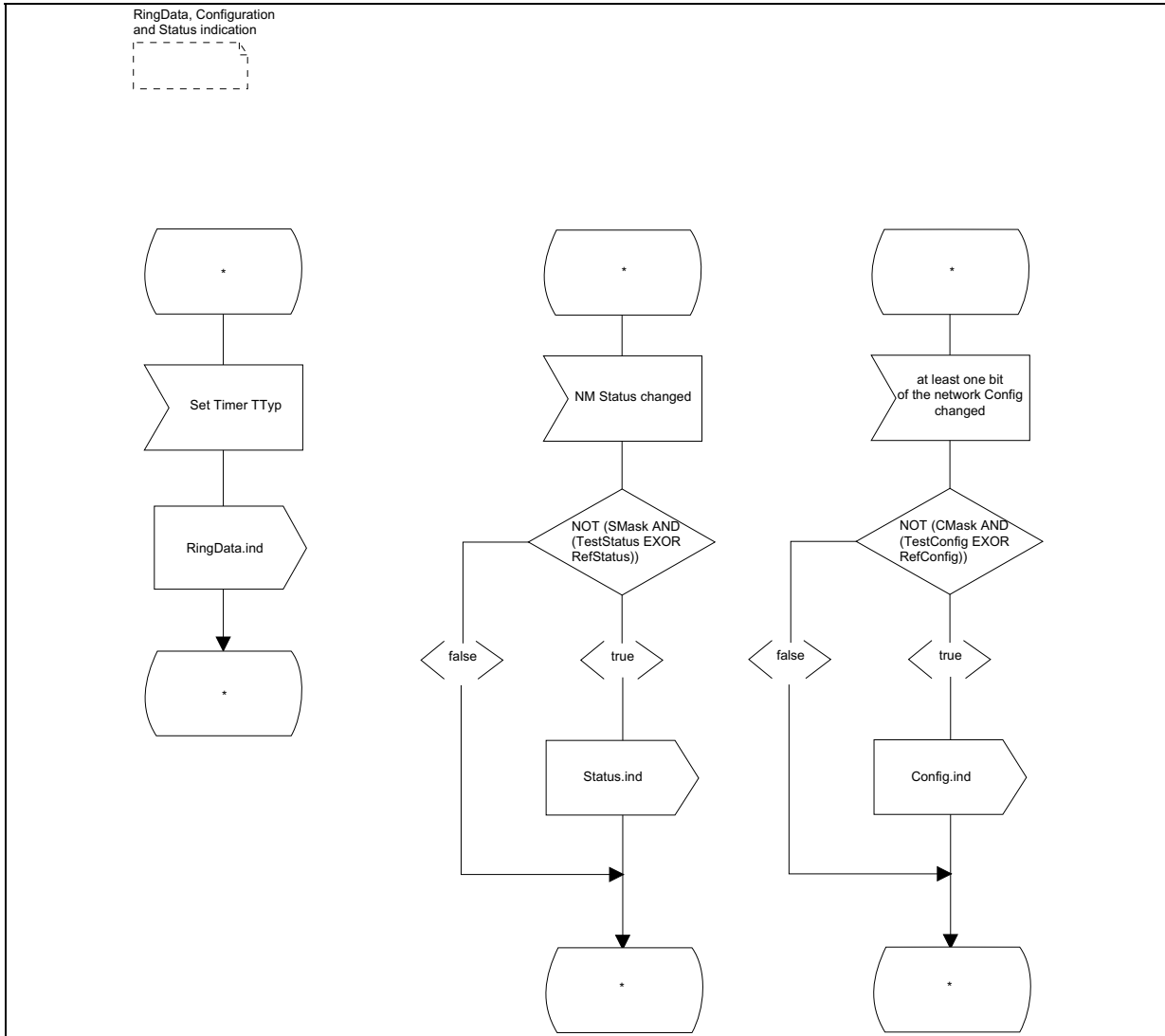

Figure 40 Indication of ring date, configuration and network status

2.2.9. Alarms inside the Network Management

2.2.9.1. Rules to design the alarms T_{Typ} and T_{Max}

The definition of the logical ring requires, that no alarm T_{Max} may run down, if a ring message is passed delayed with T_{Typ} . This derives a requirement to the precision of the alarms inside a networked system (the transmission time of a message and the runtime of the software are not taken into consideration):

$$(T_{Max})|_K > (T_{Typ})|_J \quad K, J \in [0; N - 1]$$

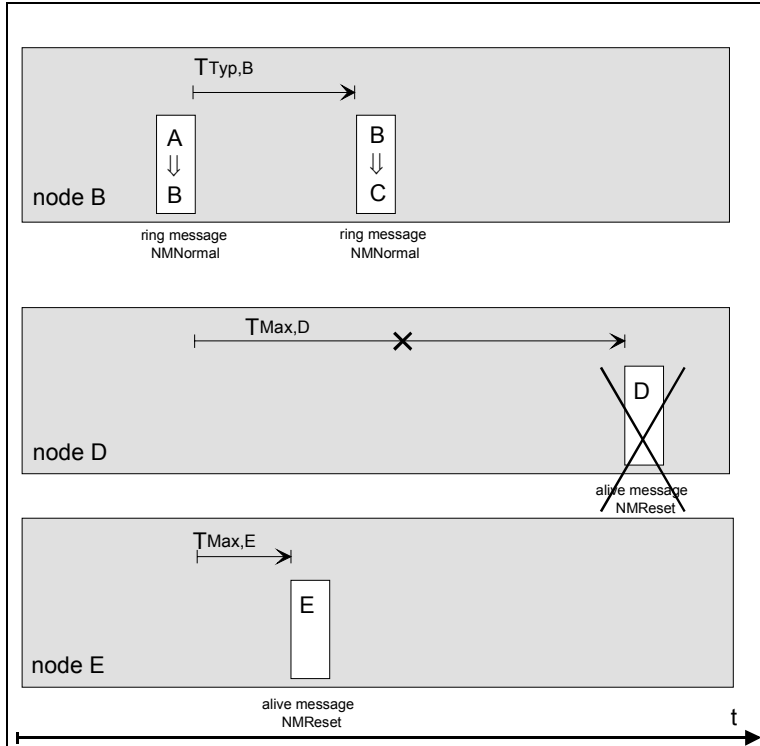
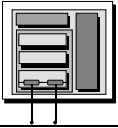

Figure 41

Effect of the condition

$$(T_{Max})_K > (T_{Typ})_J$$

$$K, J \in [0, N-1].$$

condition TRUE:

The Node D recognizes the correct running of the logical ring.

condition FALSE:

The node E recognizes the failure of another node although the ring is running perfectly.

The failure of a monitored node has to be recognized by all the other nodes inside the logical ring. All nodes have to be in NMNormal again, when the 1st ring message is transmitted after NMReset. This derives a requirement to the precision of the alarms inside a networked system (the transmission time of a message and the runtime of the software are not taken into consideration):

$$(T_{Max} + T_{Typ})_K > (T_{Max})_J \quad K, J \in [0; N-1]$$

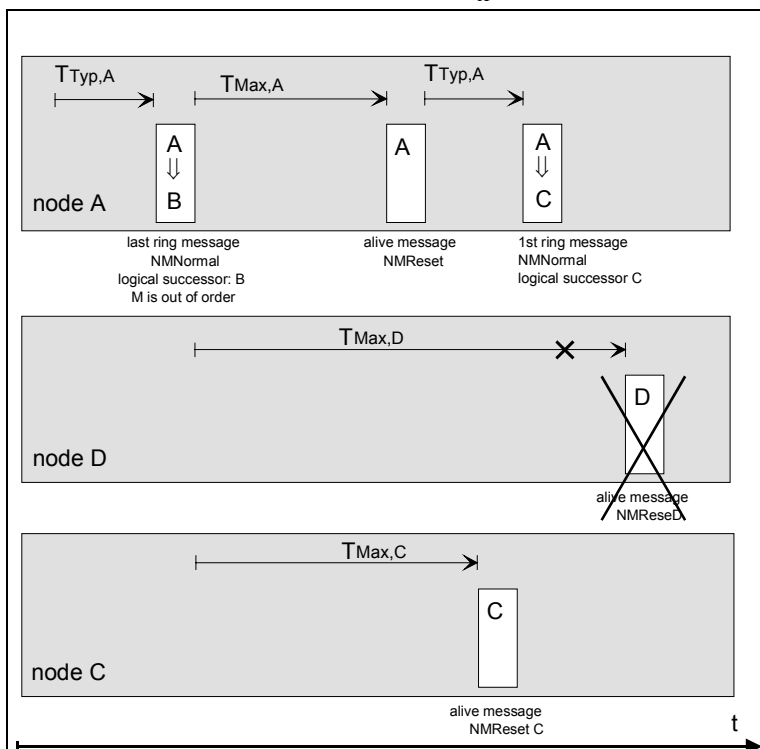

Figure 42

Effect of the condition

$$(T_{Max} + T_{Typ})_K > (T_{Max})_J$$

$$K, J \in [0, N-1].$$

condition FALSE:

The node D does not recognize the failure of the node B.

condition TRUE:

The node C recognizes the failure of the node B.

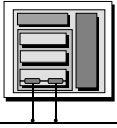

Each of this alarms has to be provided with a tolerance (...|_{min} and ...|_{max}) for every node. Inside a network all nodes must meet both requirements:

$$\left(T_{Max}|_{min} + T_{Typ}|_{min} \right) \Big|_K > \left(T_{Max}|_{max} \right) \Big|_J \quad K, J \in [0; N - 1]$$

$$\left(T_{Max}|_{min} \right) \Big|_K > \left(T_{Typ}|_{max} \right) \Big|_J \quad K, J \in [0; N - 1]$$

2.2.9.2. Rules to design the alarm T_{Error}

No important requirements for the alarm T_{Error}, which should be taken into consideration, exist. A useful value of the alarm T_{Error} is the value of T_{Typ} multiplied by 10. Tolerance calculations are insignificant.

2.2.9.3. Rules to design the alarm T_{WaitBusSleep}

After the successful transmission of the ring message with a set bit sleep.ack, there still can be user messages in the transmit queues. Nodes in the state limp-home are transmitting limp-home messages delayed by T_{Error}. Several limp-home messages can be received in this time period thus a transition in the state NMBusSleep is possible without trouble.

The timer T_{WaitBusSleep} is defined in addition to the timer T_{Error}. T_{WaitBusSleep}|_{min} ≥ T_{Error}|_{max} should be valid network wide. T_{WaitBusSleep} is selected typically to 1.5 times of T_{Error}.

2.2.9.4. Design of a system

System requirements result from the requirements to the single alarms.

$$\text{recognizing a node failure:} \quad \Delta T_{Max} = T_{Typ}|_{min} f_S \quad 0 < f_S < 1$$

$$\text{recognizing the logical ring:} \quad T_{Typ}|_{max} = T_{Max}|_{min} f_R \quad 0 < f_R < 1$$

The tolerances of both alarms should be adapted to each other.

$$\text{precision:} \quad \Delta T_{Typ} = \Delta T_{Max} f_\Delta$$

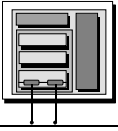

The solution to determine the system requirements is:

$$T_{Typ}|_{max} = T_{Typ}|_{min} (1 + f_S f_{\Delta})$$

$$T_{Max}|_{min} = T_{Typ}|_{min} \frac{1 + f_S f_{\Delta}}{f_R}$$

$$T_{Max}|_{max} = T_{Typ}|_{min} \left(f_S + \frac{1 + f_S f_{\Delta}}{f_R} \right)$$

The designer of a system has to fix the values $T_{Typ}|_{min}, f_S, f_R, f_{\Delta}$ inside the whole network.

2.2.9.4.1. Worst Case

The worst case design points out the limit of the logical ring. The tolerances are selected for the perfect running of the logical ring in case of ideal communication system (e.g. the transmission time of a message and the runtime of the software disappears).

recognizing a node failure: $\Delta T_{Max} = T_{Typ}|_{min} \Rightarrow f_S = 1$

recognizing the logical ring: $T_{Typ}|_{max} = T_{Max}|_{min} \Rightarrow f_R = 1$

precision: $\Delta T_{Typ} = \Delta T_{Max} f_{\Delta}$

worst case system requirements: $T_{Typ}|_{max} = T_{Typ}|_{min} (1 + f_{\Delta})$

$$T_{Max}|_{min} = T_{Typ}|_{min} (1 + f_{\Delta})$$

$$T_{Max}|_{max} = T_{Typ}|_{min} (2 + f_{\Delta})$$

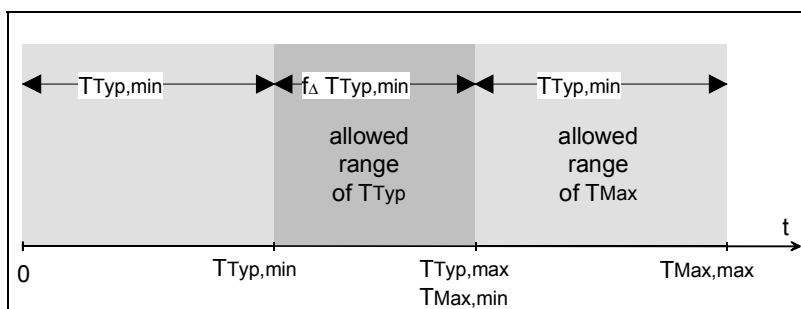

Figure 43

Worst case system design of the alarms inside the NM.

2.2.9.4.2. Example

The designer of the system fixed the values $T_{Typ}|_{min}, f_S, f_R, f_{\Delta}$ exemplary.

$$T_{Typ}|_{min} = 70ms \quad f_S = 0.92 \quad f_R = 0.5 \quad f_{\Delta} = 0.62$$

The system wide minimum and maximum values of the alarms T_{Typ} and T_{Max} result from the fixed values $T_{Typ}|_{min}, f_S, f_R, f_{\Delta}$:

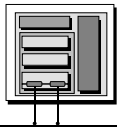

$$T_{Typ} \Big|_{\max} = 110ms$$

$$T_{Max} \Big|_{\min} = 220ms$$

$$T_{Max} \Big|_{\max} = 284ms$$

Every node has to guarantee that their alarms remain inside the fixed limits.

Example: System design

$$T_{Typ} = 70ms \dots 110ms$$

$$T_{Max} = 220ms \dots 284ms$$

$$T_{Error} = \dots 1s \dots$$

$$T_{WaitBusSleep} = \dots 1.5s \dots$$

3. Indirect Network Management

According to system design aspects, direct monitoring of the nodes may be impossible or non-desirable. This could be the case for example for very simple or time-critical applications.

Therefore mechanism of indirect monitoring is introduced. This network management is based on the use of monitored application messages. Therefore indirect monitoring is limited to nodes that periodically send messages in the course of normal operation.

In this case, a node emitting such a periodical message is monitored by one or more other nodes receiving that message. Nodes whose normal functionality is limited to receiving must send a dedicated periodic message in order to be monitored.

3.1. Concept

3.1.1. Node Monitoring

Indirect network management uses monitoring of periodic application messages to determine states of nodes connected to the network. It does not make use of dedicated network management messages.

3.1.1.1. Node states

Emitter states

For a given node i , emitter states are used to check that node i , which is supposed to emit information on the bus, is indeed able to transmit.

- node is not mute → specific application message transmitted

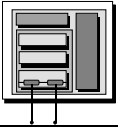

- node is mute → specific application message not transmitted during a time-out

Node state "mute" can be extended to several state types (see "Extended node states").

Receiver states

A given node *i* monitors a subset of *k* nodes on the network: node *i* monitors only **source nodes**, from which it receives cyclic application messages. Therefore, node *i* will maintain a set of *k* receiver states, where *k* is the number of source nodes monitored by node *i*. Receiver states are used to check that node *i*, which is supposed to receive information from its *k* other source nodes, indeed receives information from each of its sources.

- node is present → specific application message received
- node is absent → specific application message not received during a time-out

Node state "absent" can be extended to several state types (see "Extended node states").

3.1.1.2. Extended Node states

Extended Emitter states

- node is not mute statically → specific application message transmitted
- node is mute statically → specific application message not transmitted during a "long" time (several time-outs)

Extended Receiver states

- node is present statically → specific application message received
- node is absent statically → specific application message not received during a "long" time (several time-outs)

3.1.2. Configuration-Management

3.1.2.1. Configuration

The configuration puts together the node states of all the monitored nodes determined by the NM.

Target Configuration

The application recognizes node failures by comparison of the configuration (determined by the NM) with a target configuration. This target configuration may normally change depending on vehicle operation (e.g. nodes can appear and disappear from the network depending on ignition switch position).

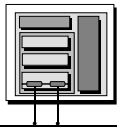

Remark

The target configuration is not located inside NM. Several target configurations and several masks can be pre-programmed in the application. By using these masks depending on vehicle operation, the application is then able to filter information provided by NM by itself and recognize node failures.

3.1.2.2. Extended Configuration

The extended configuration puts together the extended node states of all the monitored nodes determined by the NM.

3.1.3. Standard Task

3.1.3.1. Network status

The Network status is a set of information relating to local node hardware interface operation and local NM internal operating states.

Network Status	Interpretation
Operating mode of network interface	0 No error ¹⁾
	1 Error, Bus blocked ²⁾
Operation modes	0 NMON
	1 NMOff
	0 no NMLimpHome
	1 NMLimpHome
	0 no NMBusSleep
	1 NMBusSleep
	0 no NMWaitBusSleep
	1 NMWaitBusSleep

Table 8 Encoding of the network status

¹⁾ Reception and transmission of application messages successful

²⁾ e.g. CAN-busoff

3.1.3.2. Extended network status

The extended Network status is specific to the user.

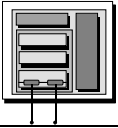

Network Status	Interpretation
Operating mode of network interface	00 No error ¹⁾
	01 Error, Communication possible ²⁾
	10 Error, Communication not possible ³⁾
	11 reserved
...	

Table 9 Example of encoding of the extended network status.
¹⁾ Reception and transmission of application messages successful
²⁾ communication via one wire
³⁾ e.g. CAN-busoff for a "long" time

3.1.4. Monitoring Mechanisms

In order to evaluate node states and network status, Indirect Network Management provides three non-exclusive mechanisms of monitoring.

A) transmission

Determination of the emitter states by using transmission monitoring scheme: transmission problems are detected by checking local confirmations related to transmissions of a unique periodic application frame chosen among those to be sent. This local confirmation is used to set the emitter states accordingly.

Example

If a message is correctly transmitted in case of CAN, it is then acknowledged on the bus. If the transmission fails, there is no acknowledgement and after a time-out, node i is considered "mute" by the NM.

B) reception

Determination of the set of receiver states by using reception monitoring scheme : node i checks the presence of all its source nodes by monitoring the reception of a chosen cyclic frame per each remote source.

If the supervised message of node k is not received at least once by node i before a configurable time-out, node k is then considered absent.

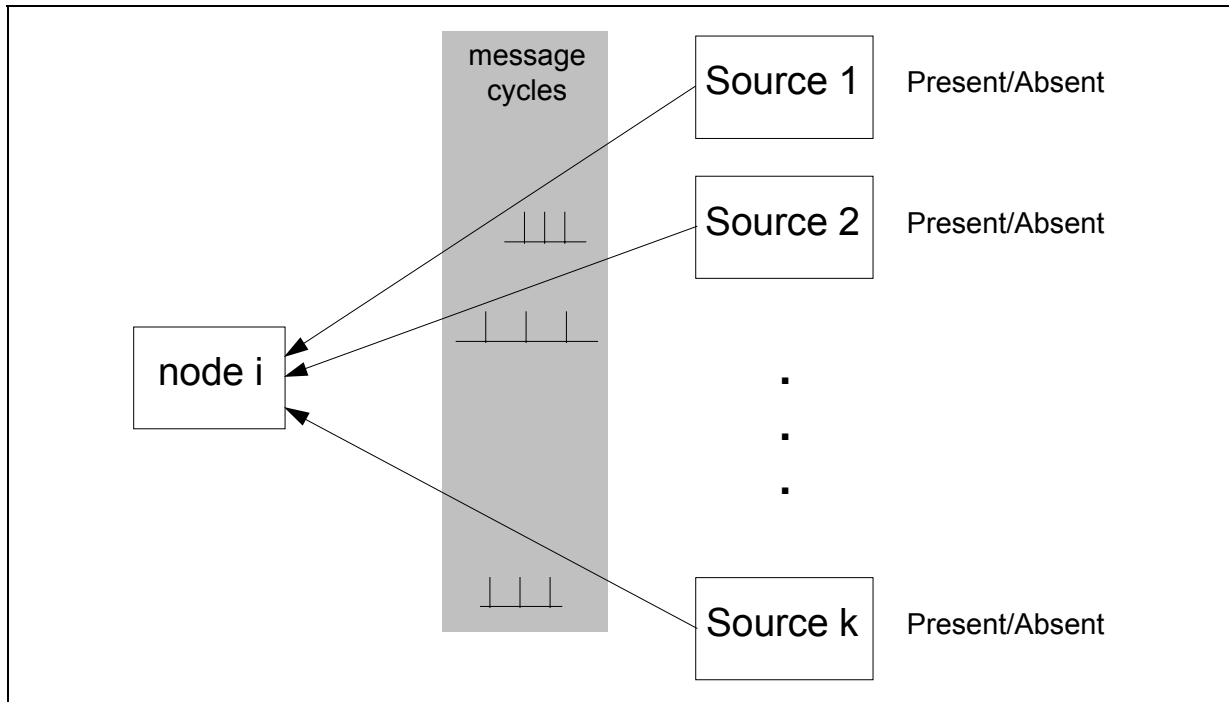
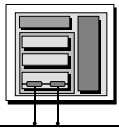

Figure 44 Reception monitoring

C) status signal

Determination of Network Interface status by using controller indications from communication Data Link Layer, which itself uses low level controller or driver information.

Example

If the bus is blocked in case of CAN, controller indicates a "bus off" error to upper layers.

3.1.5. Monitoring time-outs

OSEK Indirect NM transmission and reception monitoring is based on two possible time-out monitoring mechanisms.

- all messages are monitored by one global time-out TOB (time-out for observation)
- each message is monitored by its own dedicated time-out.

3.1.5.1. One global time-out

The global monitoring time-out is located inside NM and is used as a time-window observation.

node present/not mute	at least one message has been transmitted or received from node k during the global time-out (time window observation)
node absent/ mute	no message has been transmitted or received from node k during the global time-out (time window observation)

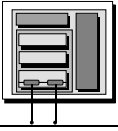

The monitoring time-out has to be adapted to the longest time requirement among all the monitored application messages.

Hint

The global time-window observation is handled in the SDL diagrams by a private configuration and a public configuration.

3.1.5.2. One monitoring time-out per message

In this case, Indirect NM uses "COM Deadline Monitoring"¹ mechanisms to monitor dedicated application messages. Time-outs are located at Interaction Layer level. NM is informed dynamically by COM each time a message has been correctly transmitted or received, or a time-out has expired for this message.

Each monitoring time-out can be adapted to the time requirements of each monitored application message.

3.1.5.3. Internal Network Management States

The OSEK NM can enter the internal states listed hereafter:

- NMOff NM is switched off
- NMOon NM is switched on

NMOon:

- NMBusSleep NM is in sleep mode
- NMAwake Active state of the NM

NMAwake:

- NMNormal Processing of indirect node monitoring
- NMLimpHome Handling of failure in own node
- NMWaitBusSleep Synchronizing the network wide jump to the state BusSleep

¹ see paper OSEK/VDX COM current version

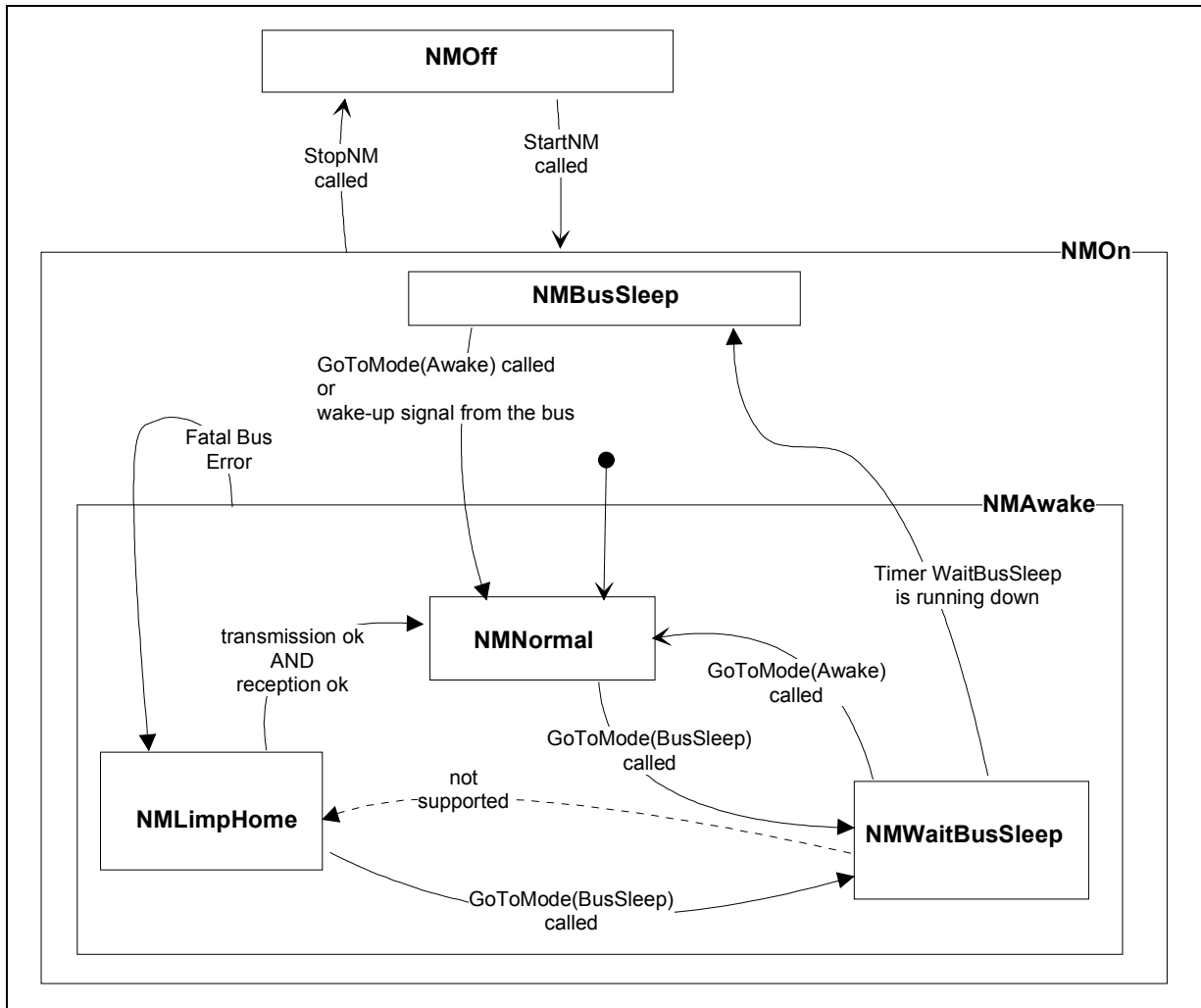
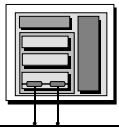

Figure 45 Simplified state transition diagram of the indirect NM.

NMLimpHome

This state is entered after a failure of the network communication interface, communication not being operational (e.g. Bus-Off failure for CAN).

Node states values (e.g. "node absent") do not switch NM to the state NMLimpHome. NM only performs monitoring actions but has no knowledge about the expected target configuration - NM does not know if a missing node is a failure or not.

NMWaitBusSleep

This state is entered after the demand of the application for entering the BusSleep mode. It is a waiting state preparing for BusSleep mode. During this time, all other nodes have to receive the SleepMode command via their application² as well.

² see chapter "User guide"

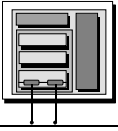

3.1.6. Operating Modes

The NM does not manage application modes, but exclusively manages NM operating modes. NM distinguishes two main operating modes. The modes of the NM are directly mapped to internal NM states.

NMAwake

In NMAwake the node monitors the selected application messages.

NMBusSleep

If a node is in NMBusSleep, it does not monitor application messages. Depending on the hardware integrated in the networks, nodes can switch into some low power mode.

The NM provides services for:

- selection of NM operation modes, and
- indication of NM operating modes.

3.2. Algorithms and behavior

3.2.1. Configuration Management

The NM supports the configuration and the optional extended configuration management. The extended configuration is specified by monitoring application messages with a "long" time. This "long" time is realized by using counters.

3.2.1.1. Counter management

The states of the extended configuration are determined by decremeting and incrementing³ specific counters and by comparing the counters with a threshold.

From the point of view of the functionality one of the values is redundant and can be selected statically. Therefore OSEK NM sets the threshold to a constant value.

³ The functions used to increment and decrement shall avoid any overflow and underflow.

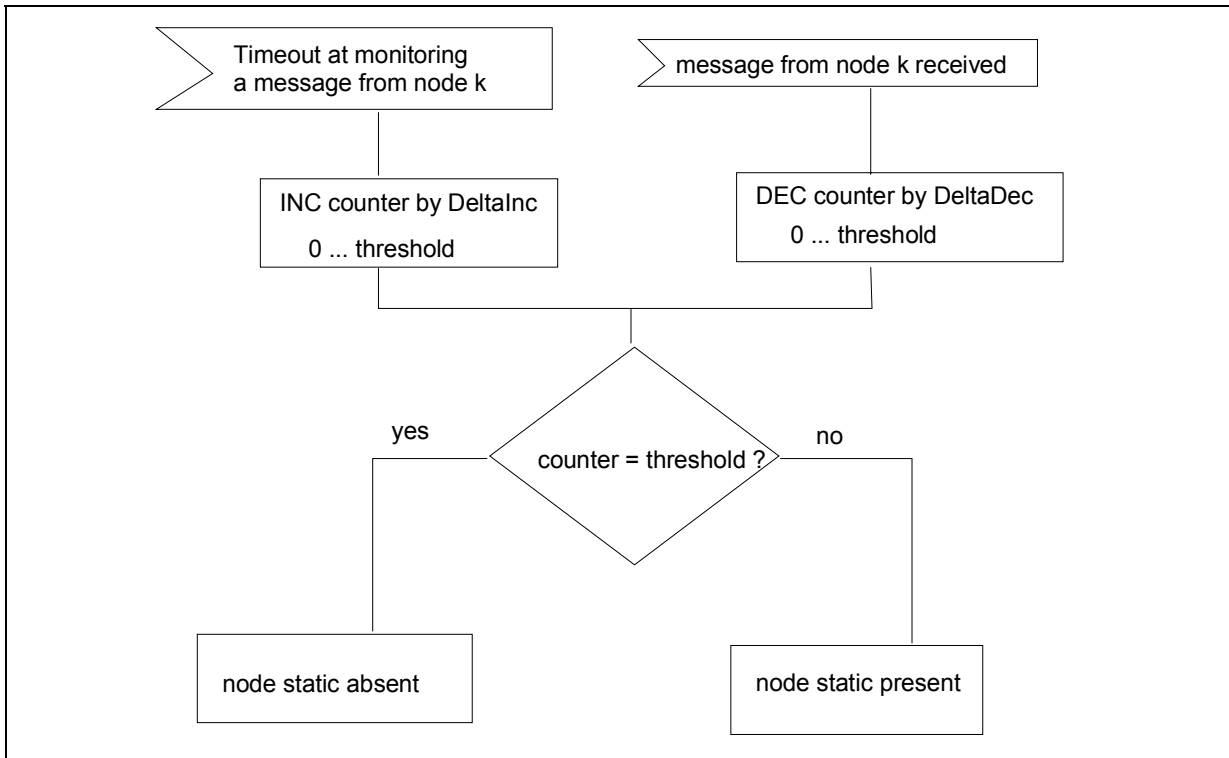
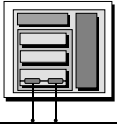

Figure 46 Extended configuration illustrated at node k.

Counter behavior and corresponding states are illustrated by the three following figures.

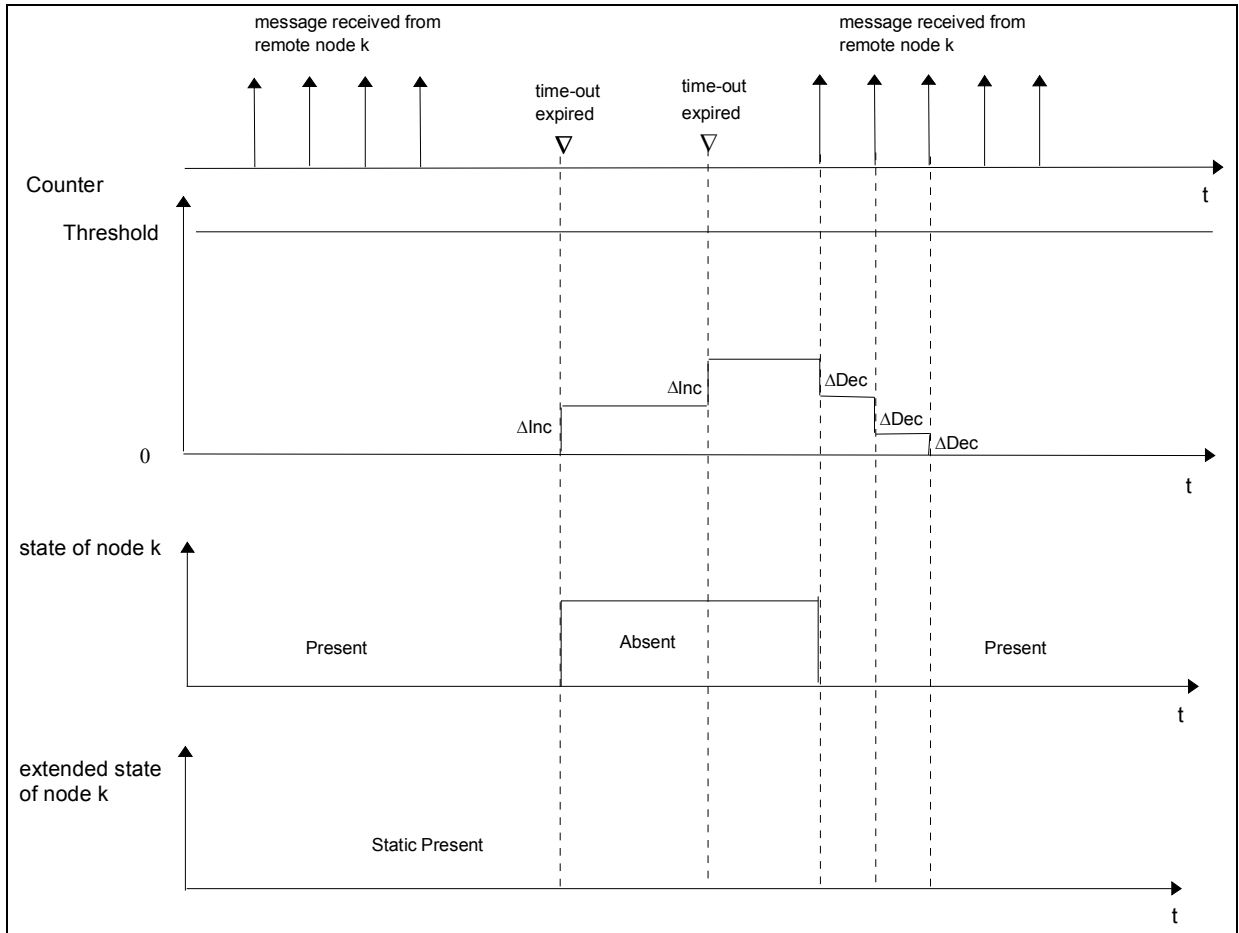
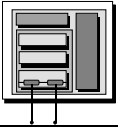

Figure 47 Extended configuration illustrated at node k in the case of a very transient state of the node - the state "static absent" will not be reached.

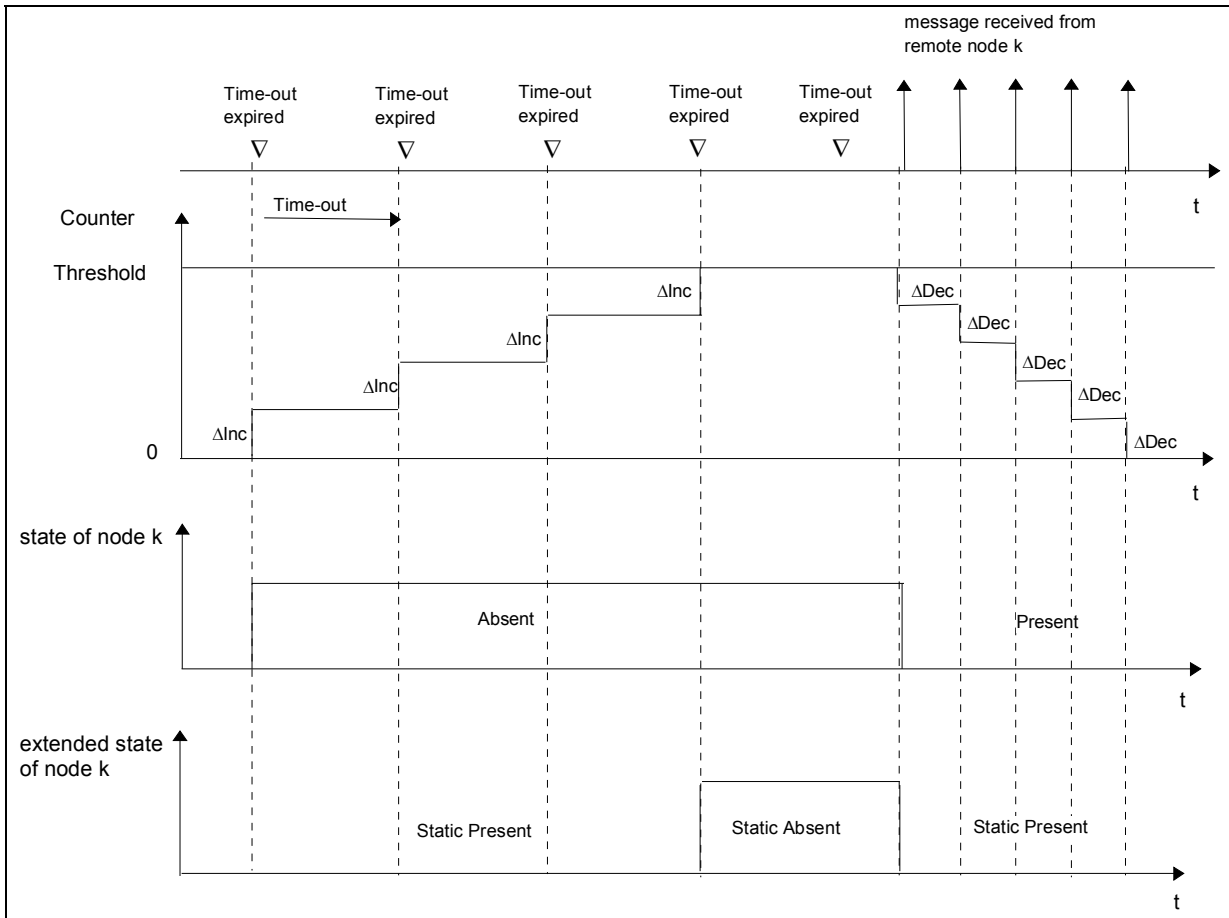
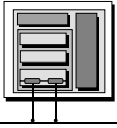

Figure 48 Extended configuration illustrated at node k in the case of a permanent state of the node.

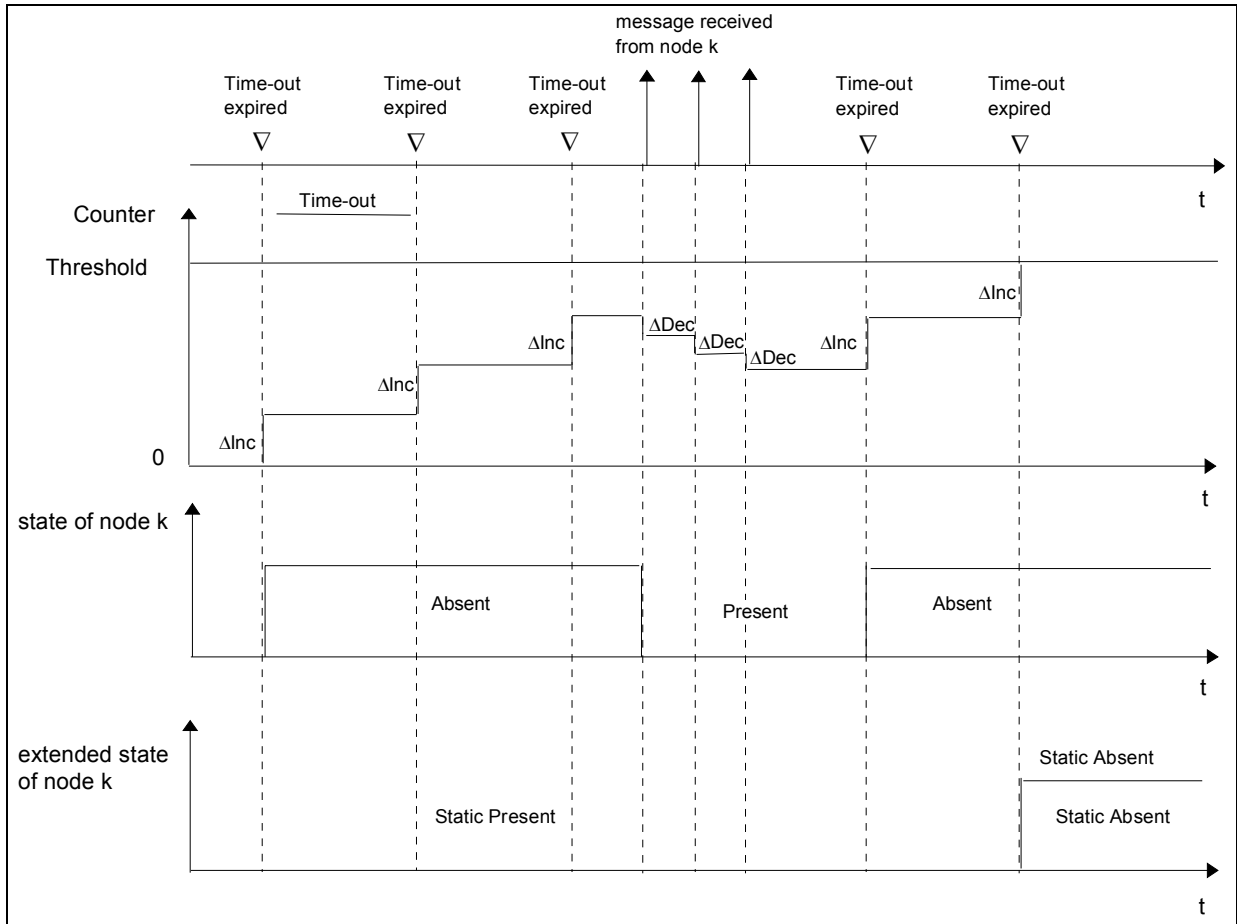
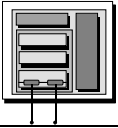

Figure 49 Extended configuration illustrated at node k in case of a repetitive state of the node.

OSEK Indirect NM static state detection algorithm is flexible and scaleable. It allows choosing different kinds of detection for static states by setting the parameters DeltaInc and DeltaDec at system generation time.

3.2.2. Operating Mode

3.2.2.1. User Guide to handle BusSleep

The NM handles power down modes on demand of the user. Net-wide negotiations are not supported. Master slave and multi master behavior can be realized by using the given services - GotoMode(Awake) and GotoMode(BusSleep).

Example: Master - Slave

The user does reserve one bit in a application message which does the master broadcast to the slaves.

- bit is set the master requires the mode NMBusSleep from all slaves
- bit is cleared the master does not require the mode NMBusSleep from any slave

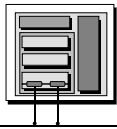

application	NMAwake	NMBusSleep
in the master	set the reserved bit and send the corresponding message call GoToMode(BusSleep) after the message has been sent via the bus	call GoToMode(Awake) clear the reserved bit and send the corresponding message
in the slave	call GoToMode(BusSleep) when receiving the set bit call GoToMode(Awake) when receiving the cleared bit	-

Table 10 Example of the application behavior to handle NMAwake and NMBusSleep according to a master slave approach.

Hint

The master and the slave behaviors can be supported by a single implementation of the indirect NM.

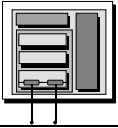

3.2.3. State Machine in SDL

3.2.3.1. SDL Model for one global time-out TOB

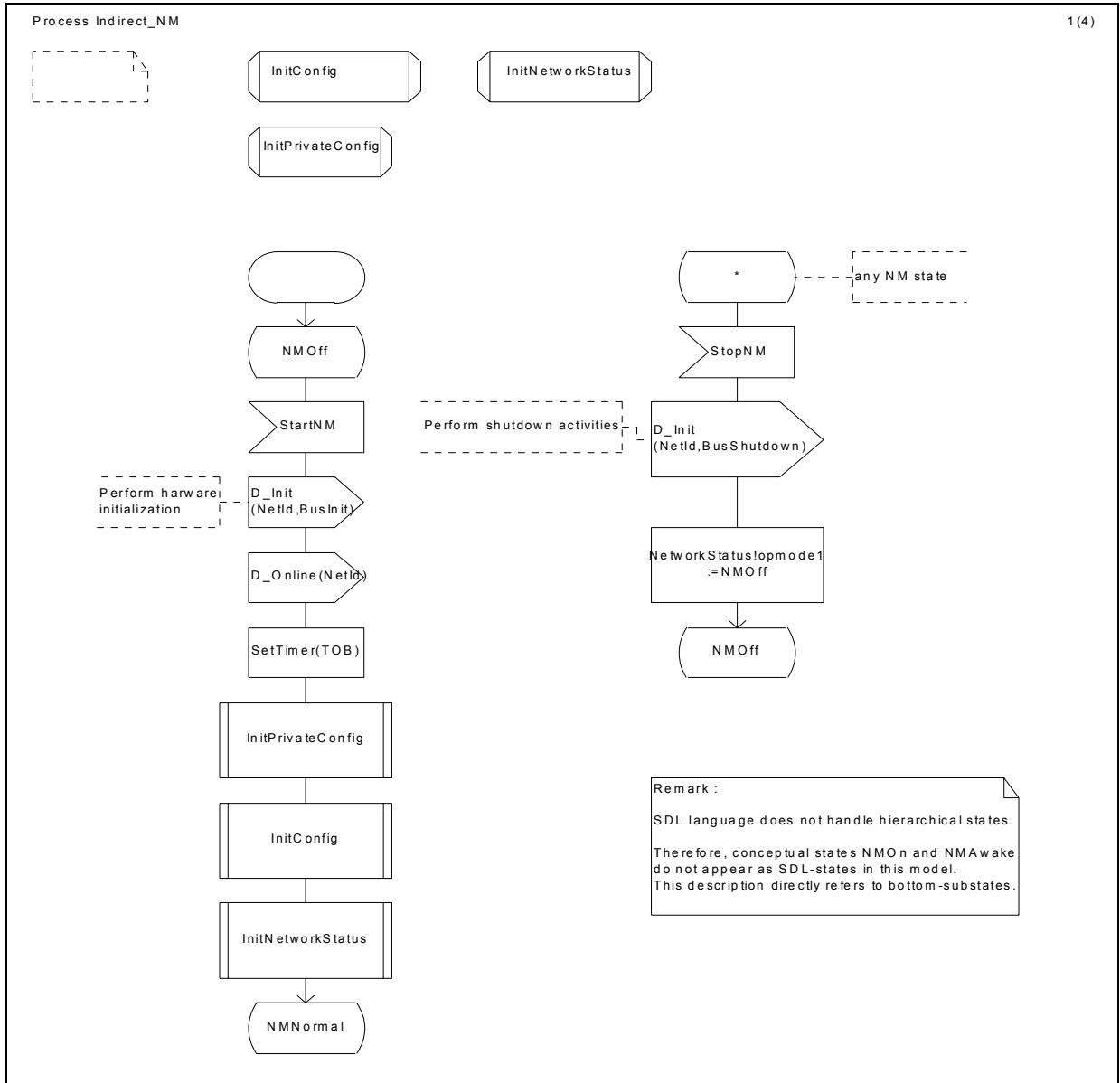

Figure 50 Handling of the services `StartNM` and `StopNM`

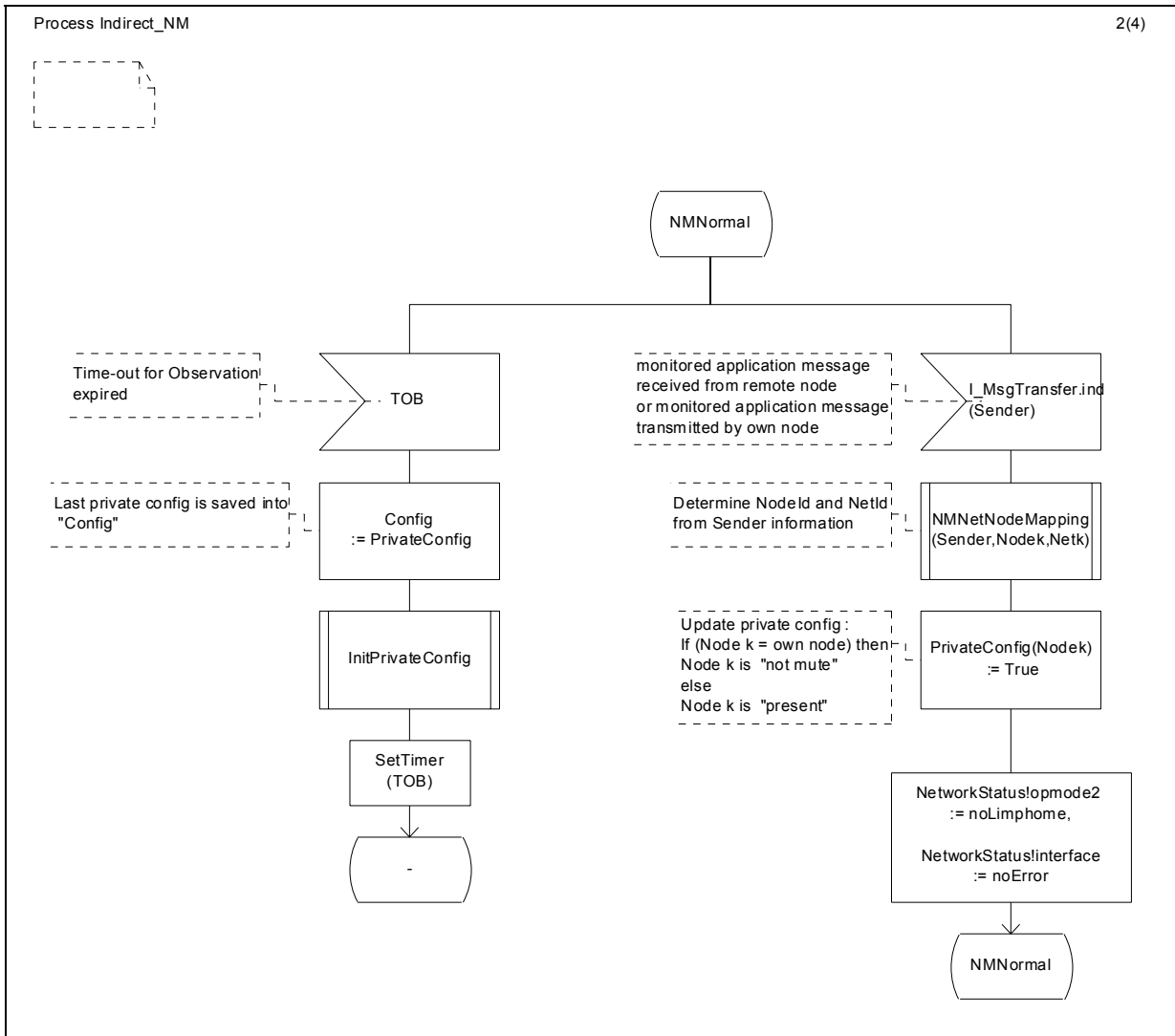
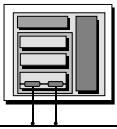

Figure 51 Handling of the events "TOB" and "message received" during state NMNormal

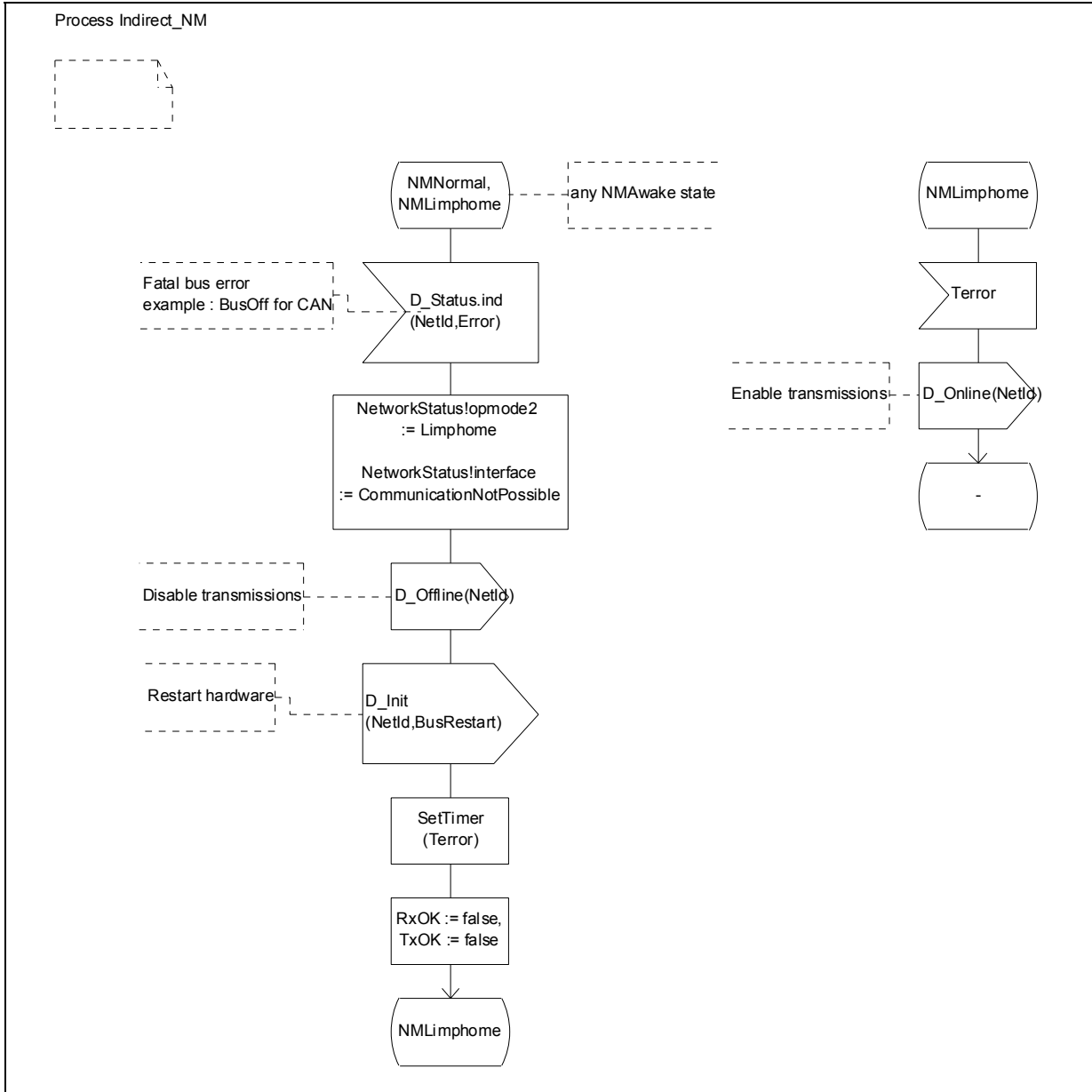
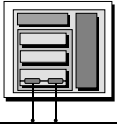

Figure 53 Handling of a fatal bus error

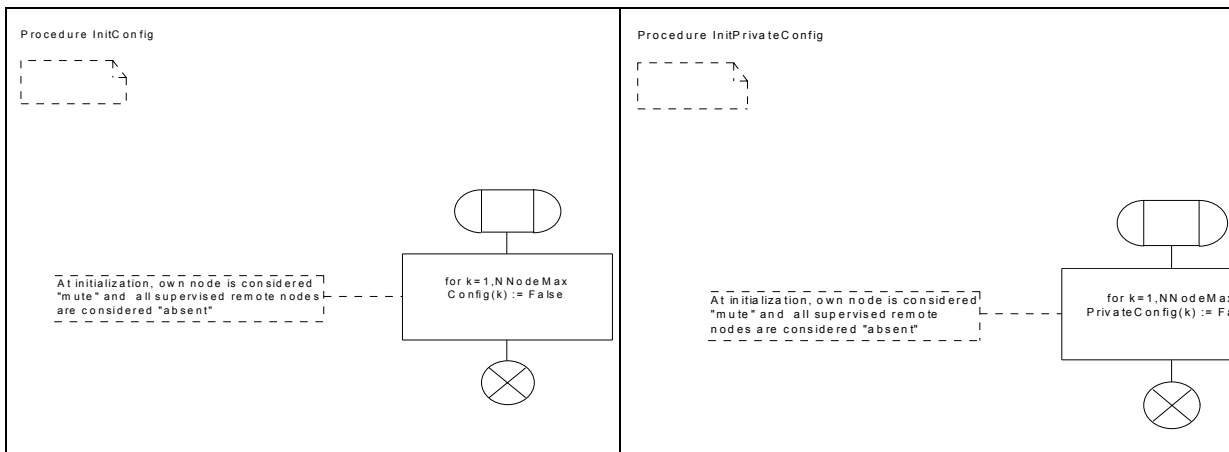

Figure 54 Initialization of the configuration

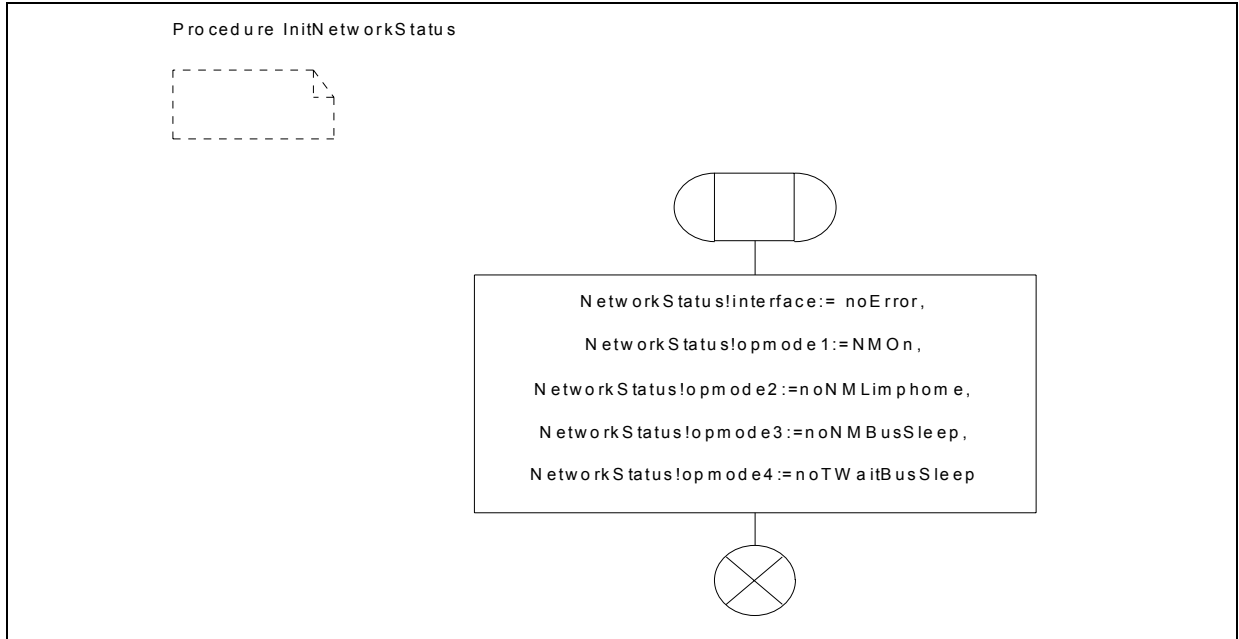
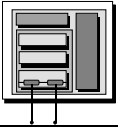
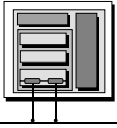

Figure 55 Initialization of the NM status



3.2.3.2. SDL Model for one monitoring time-out per message

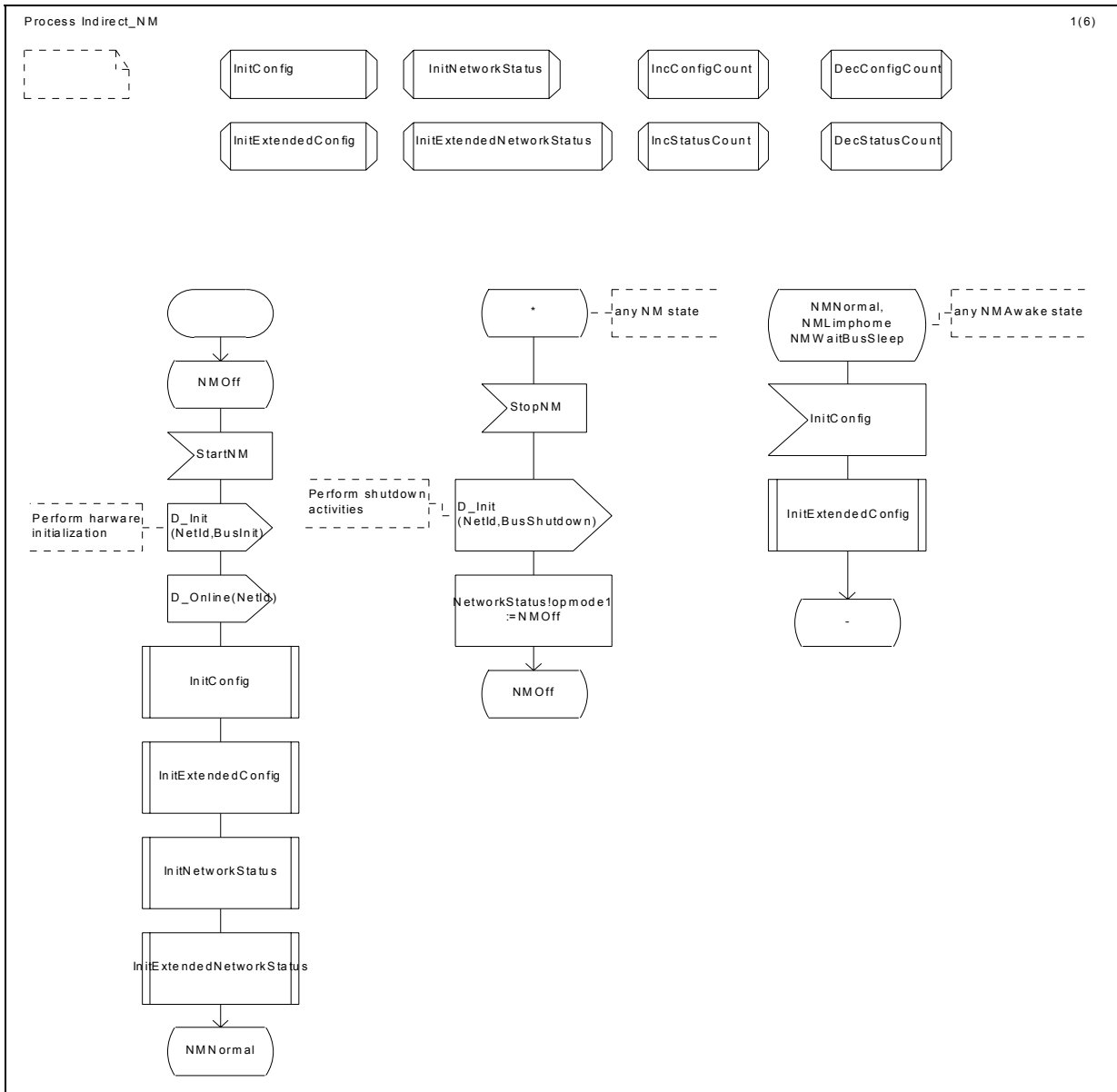

Figure 56 Handling of the services StartNM, StopNM and InitConfig

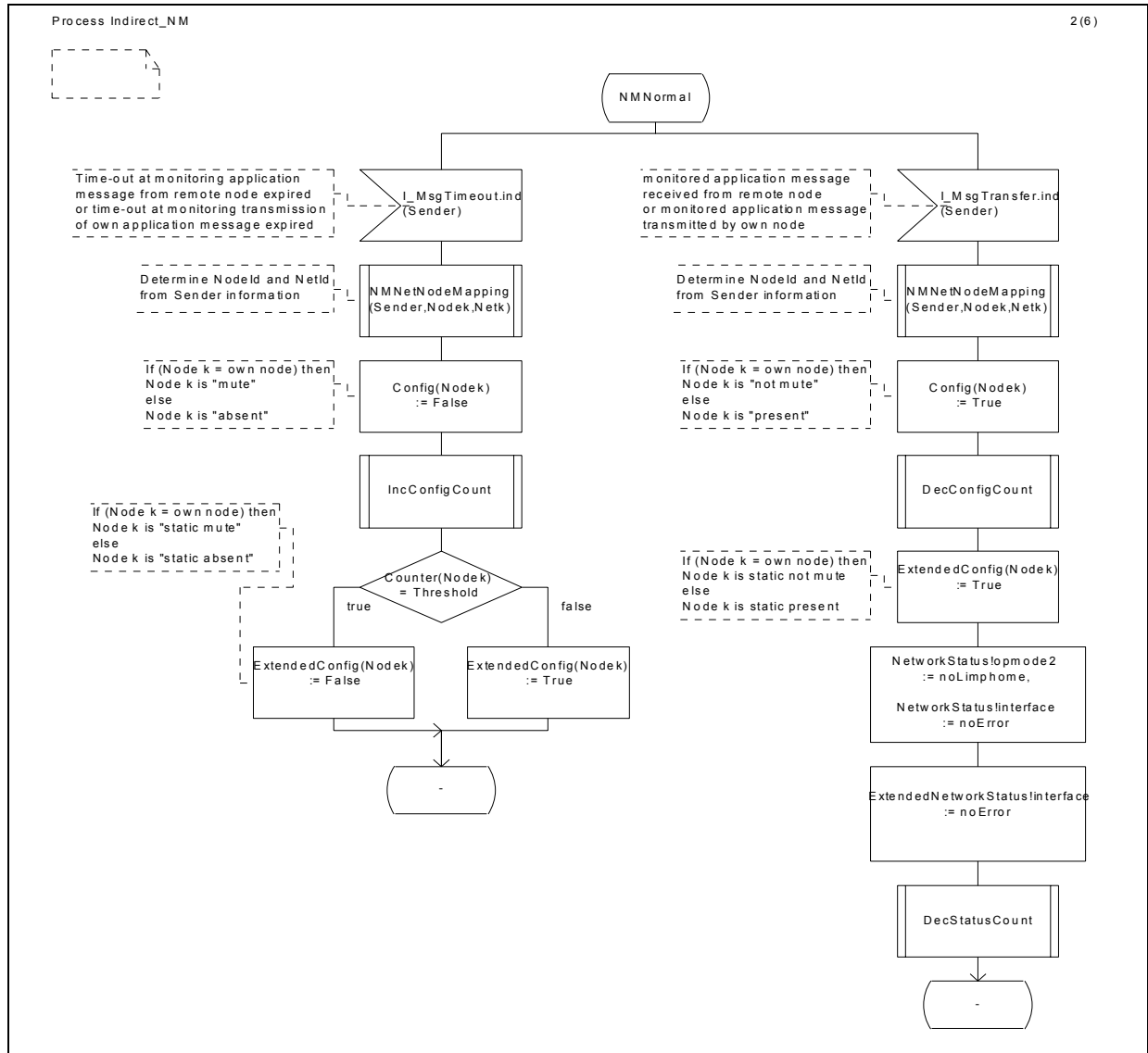
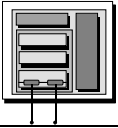

Figure 57 Handling of the events "timeout for message" and "message received" during state NMNormal

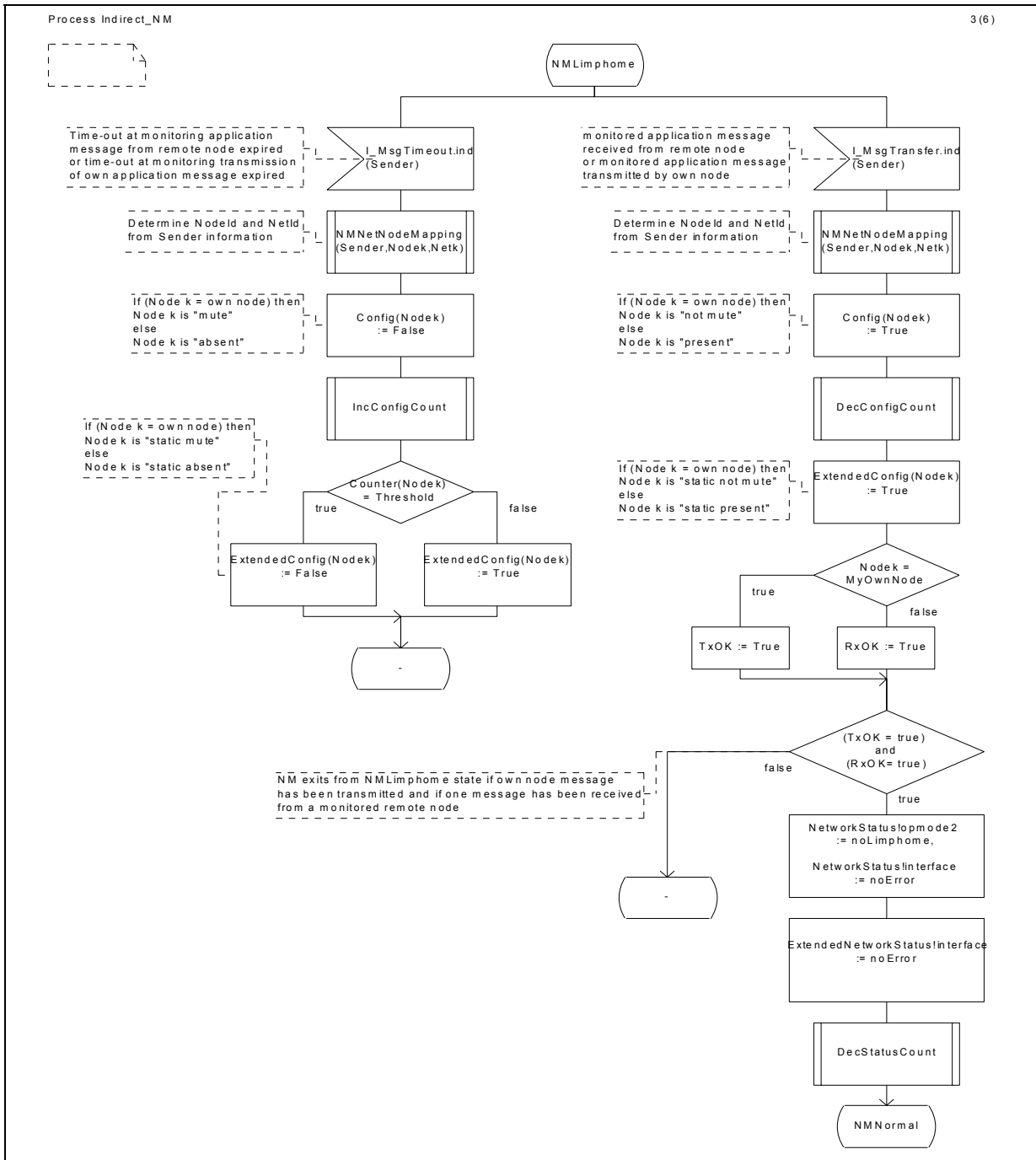
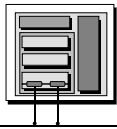

Figure 58 Handling of the events "timeout for message" and "message received" during state NMLimpHome

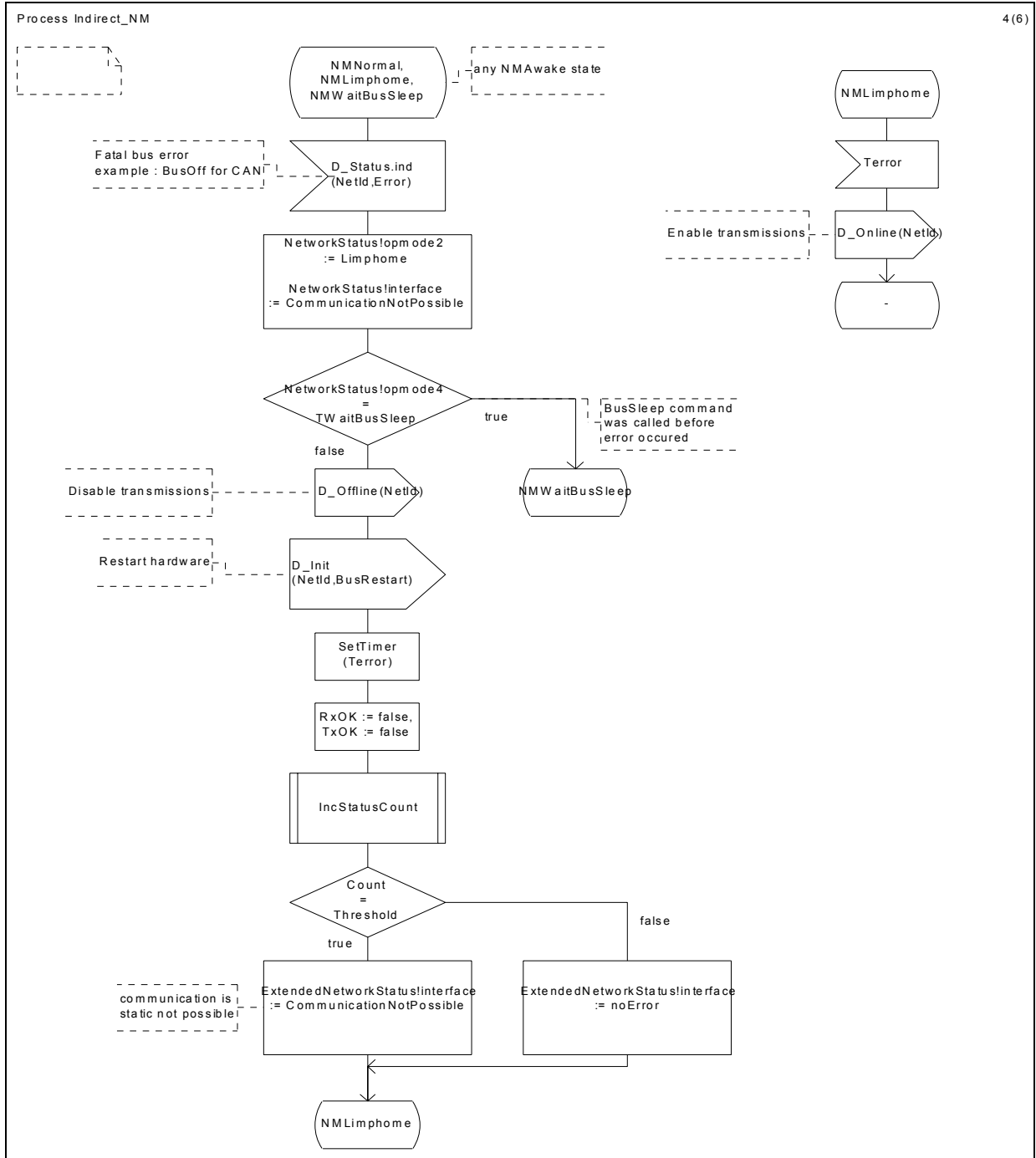
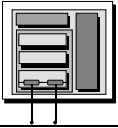

Figure 59 Handling of a fatal bus error

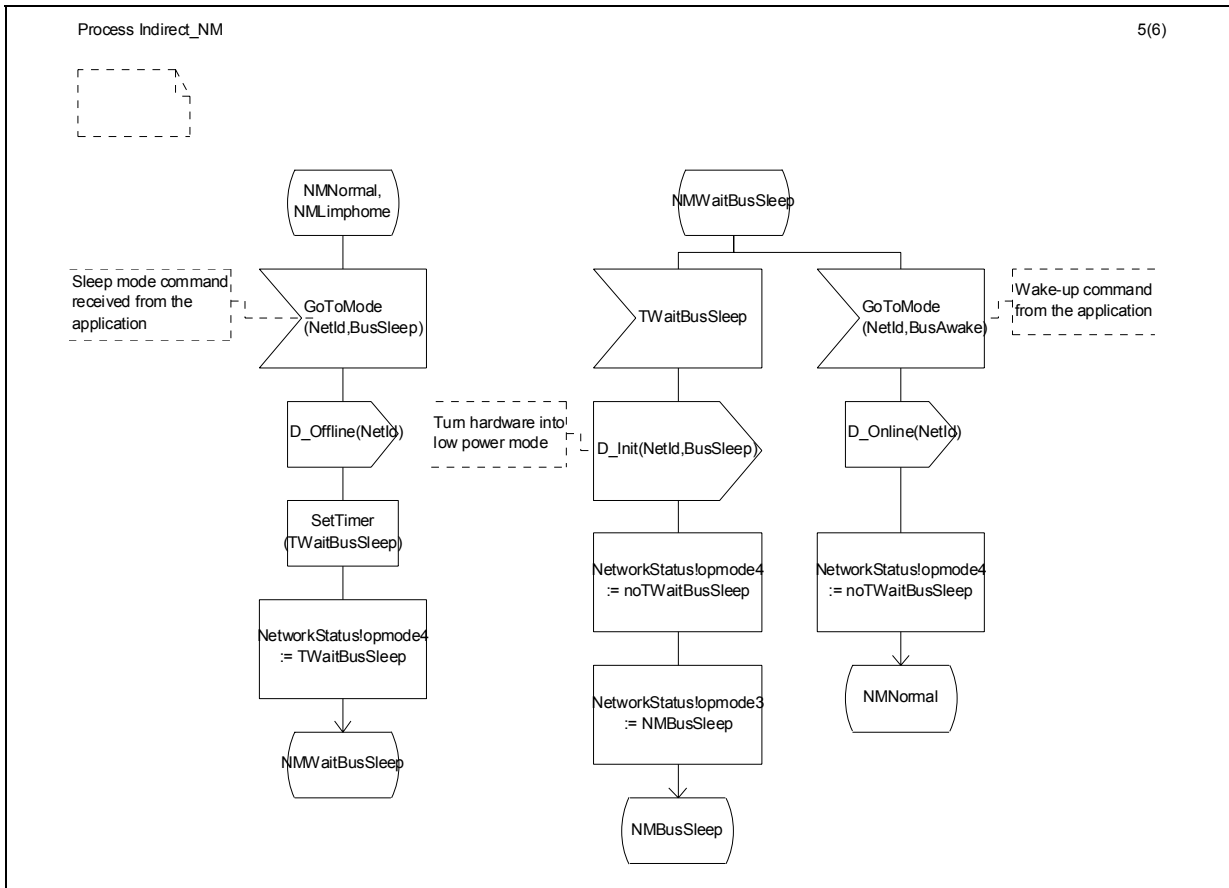
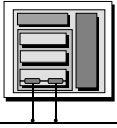

Figure 60 Handle the transition to the state NMBusSleep

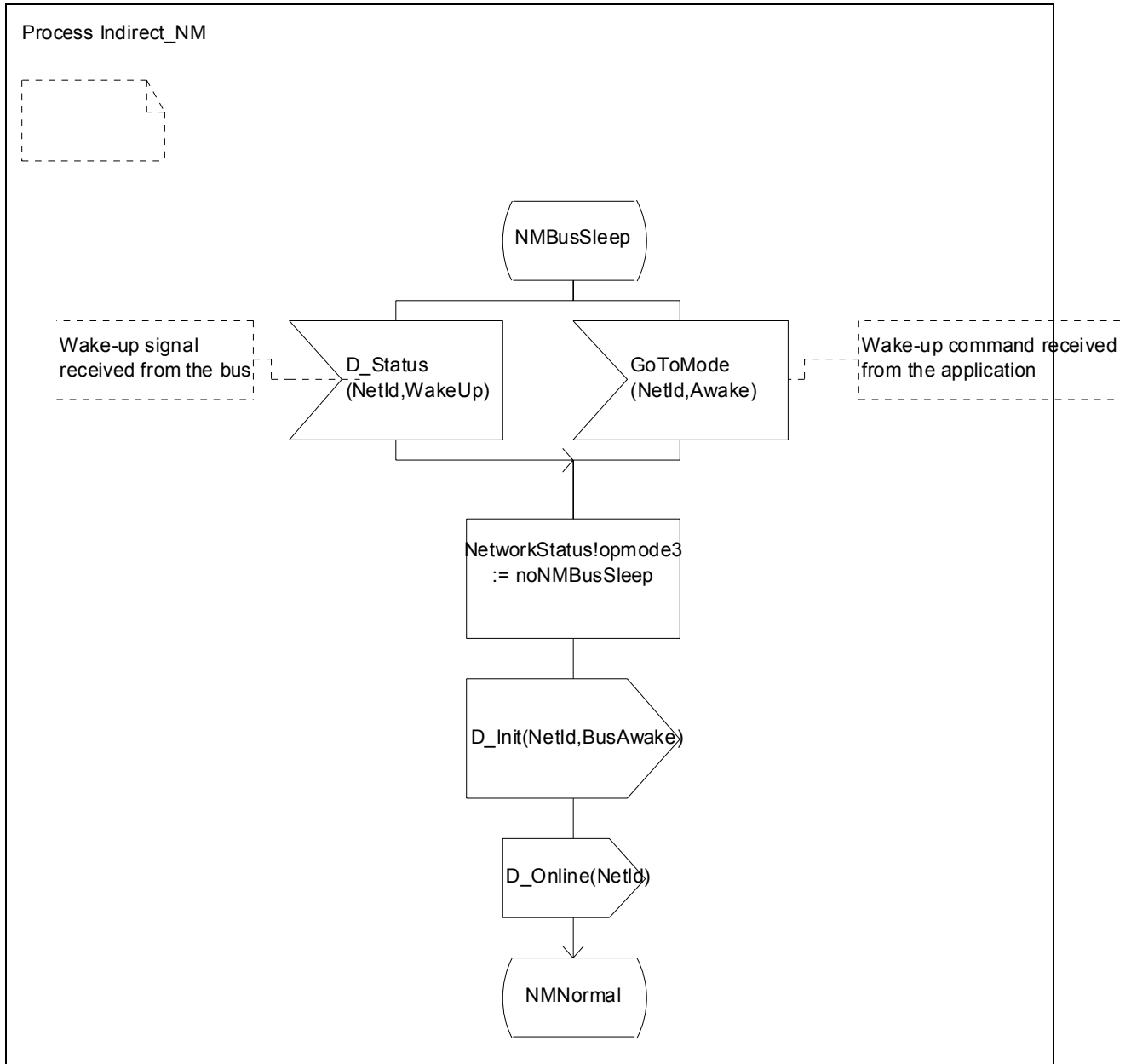
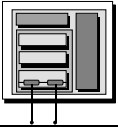

Figure 61 Handle the transition from NMBusSleep into NMNormal

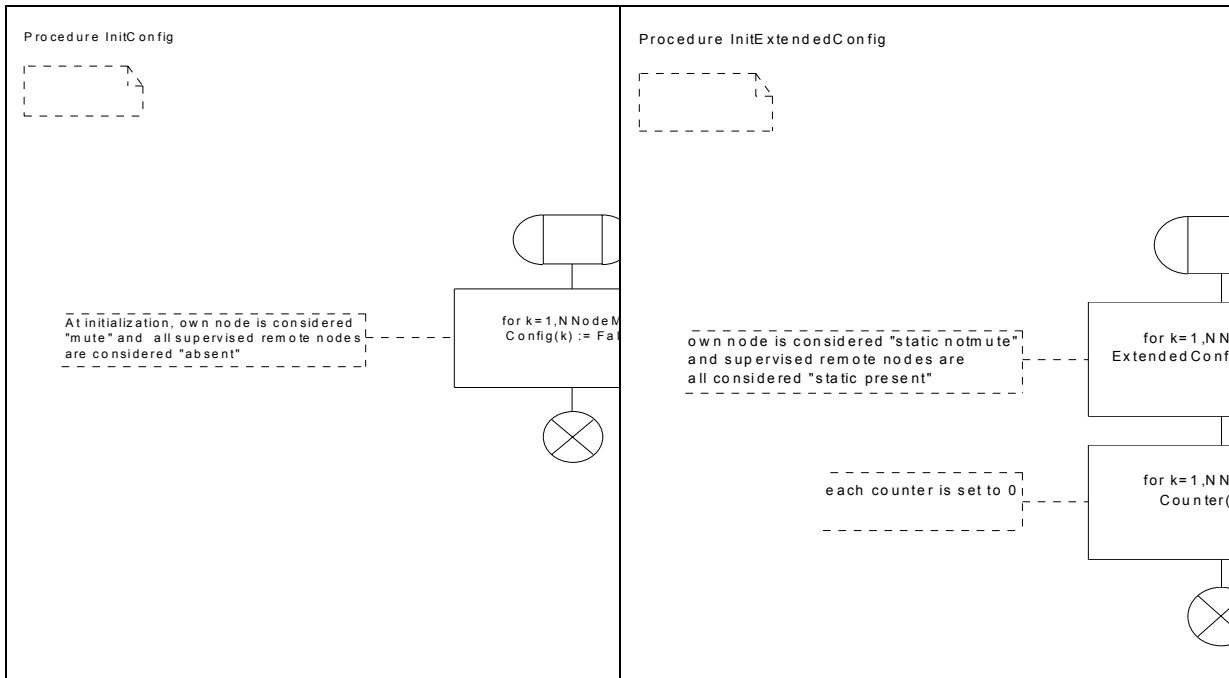
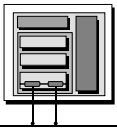

Figure 62 Initialization of the configuration

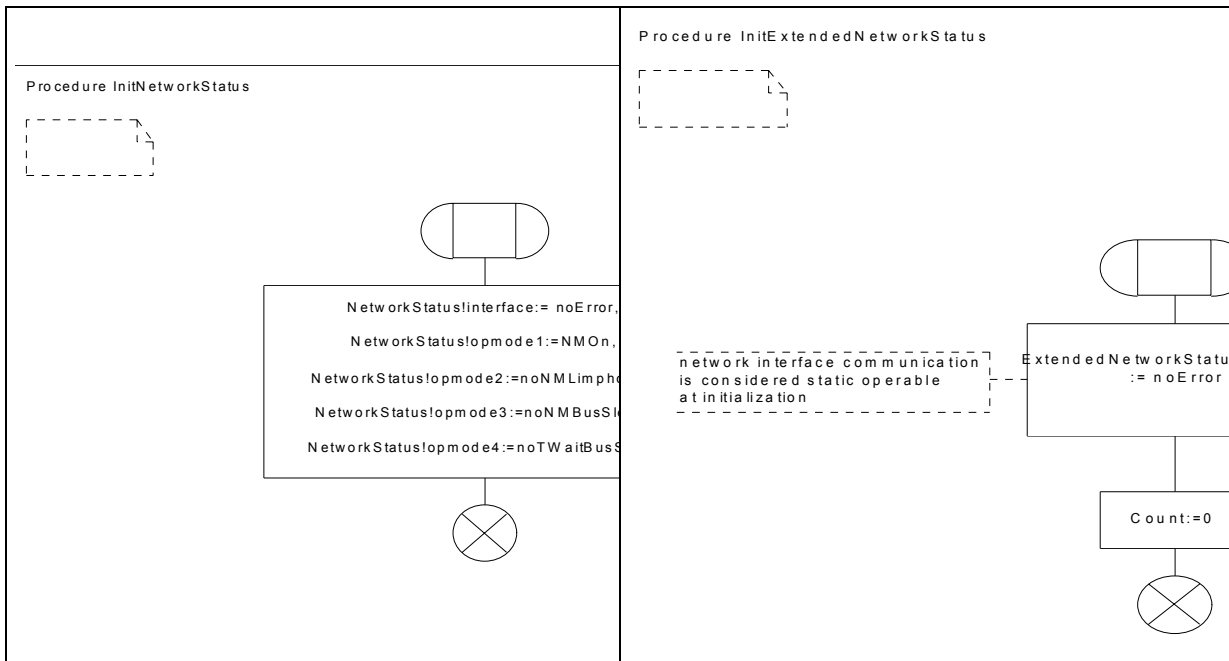

Figure 63 Initialization of the NM status

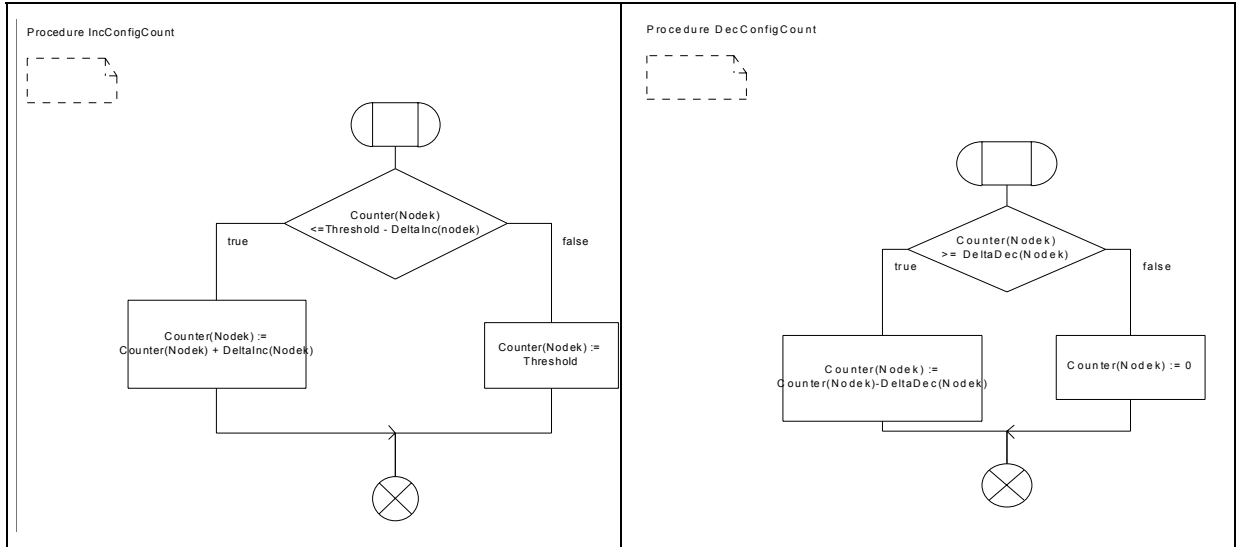
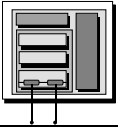

Figure 64 Decrement and increment procedures for the extended configuration

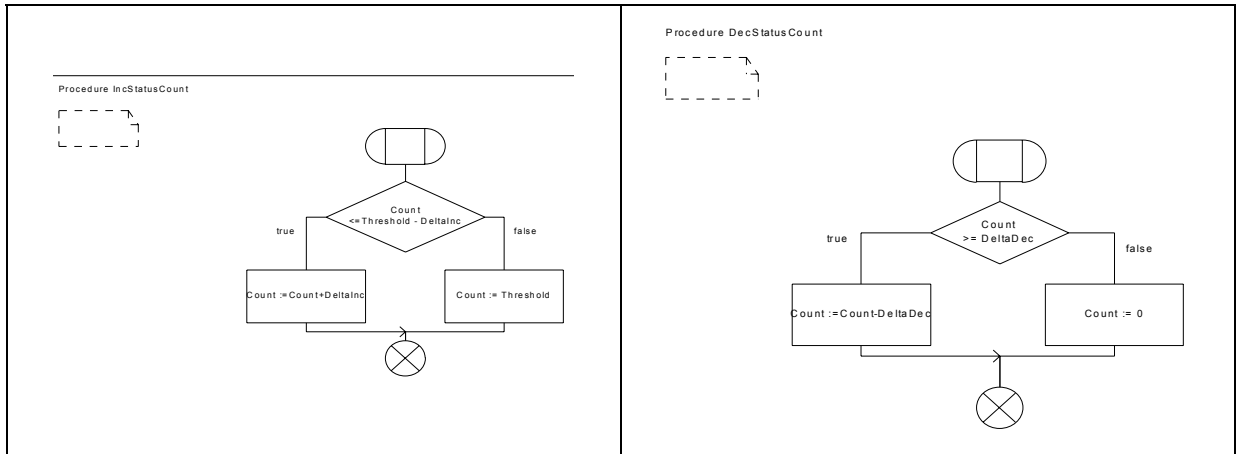

Figure 65 Decrement and increment procedures for the extended network status

4. System generation and API

4.1. Overview

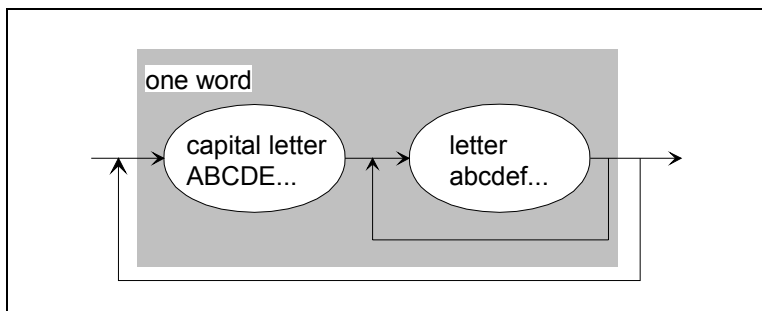
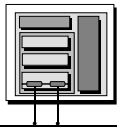

Figure 66

Syntax of a NM service.

Example:
GetConfig



	Service Call	dir. NM	ind. NM	ISL	Hook Level					Task Level	Core or Optional Service	
				I S R	E r r o r H o o k	P r e T a s k H o o k	P o s t T a s k H o o k	S t a r t H o o k	S h u t d o w n H o o k	T a s k		
Configuration management - Initialization of static parameter - Initialization of individual configurations masks - Initialization of individual target configurations - Indication of Configuration change - select the indication sensitivity - start or restart the configuration management - Make current configuration available - Comparison of two configurations	InitDirectNMPParams	✓	✓									OPT
	InitIndirectNMPParams	✓	✓									OPT
	InitCMaskTable	✓	✓									OPT
	InitTargetConfigTable	✓	✓									OPT
	InitIndDeltaConfig	✓	✓									OPT
	SelectDeltaConfig	✓	✓	✓						✓		OPT
	InitConfig	✓	✓	✓						✓		OPT
	GetConfig CmpConfig	✓	✓	✓						✓		OPT OPT
Operating mode management - Initialization of individual status masks - Initialization of individual target states - Indication of Status change - Start of NM, i.e. transition to NM mode 'NMON'. - Stop of NM, i.e. transition to NM mode 'NMShutDown' and finally to 'NMOff' - Transition to NM mode 'NMPassive' without network-wide notification - Transition to NM mode 'NMActive' after a previous call of SilentNM - Transition to a new operating mode (e.g. BusSleep, Awake) - select the indication sensitivity - Get status information (network, node) - Comparison of two states	InitSMaskTable	✓	✓									OPT
	InitTargetStatusTable	✓	✓									OPT
	InitIndDeltaStatus	✓	✓									OPT
	StartNM	✓	✓	✓						✓		CORE
	StopNM	✓	✓	✓						✓		CORE
	SilentNM	✓		✓					✓	✓		OPT
	TalkNM	✓		✓					✓	✓		OPT
	GotoMode	✓	✓	✓					✓	✓		OPT
	SelectDeltaStatus	✓	✓	✓						✓		OPT
GetStatus	✓	✓	✓						✓		OPT	
CmpStatus	✓	✓	✓						✓		OPT	
Data Field management - Indication of received data - Transmit data - Read received data	InitIndRingData	✓										OPT
	TransmitRingData	✓		✓						✓		OPT
	ReadRingData	✓		✓						✓		OPT

Table 11 Breakdown of NM API-services into core services and optional services.

✓ Call to the NM service is allowed in this level (Interrupt level ISL, Hook level and Task level)

4.2. Conventions for Service Description

4.2.1. System Generation

Within OSEK NM all system objects have to be determined statically by the user (fixed at compile time). There are no system services available to dynamically create system objects.

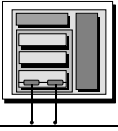

System objects have to be defined or declared for usage in the application programs' source using specific calls.

The design of system objects may require additional specific tools. They enable the user to add or to modify values which have been specified. Consequently, the system generation and the tools are also implementation specific.

4.2.2. Type of Calls

System services are called according to the ANSI-C syntax. The implementation is normally a function call, but may also be solved differently, as required by the implementation - for example by C-pre-processor macros.

4.2.3. Error Characteristics

All system services return a status to the user. The return status is E_OK if it has been possible to execute the system service without any restrictions. If the system recognizes an exceptional condition which restricts execution of any system service, a different status is returned.

If it is possible to exclude some real errors before run time, the run time version may omit the checking of these errors. If the only possible return status is E_OK, the implementation is free to not return a status.

To keep the system efficient and fast, OSEK NM does not check for all possible errors. OSEK NM assumes debugged applications, and the correct usage of the system services. It must be expected that undetected errors in the application result in undefined system behavior.

All return values of a system service are listed under the individual descriptions. The return status distinguishes between the "Standard" and the "Extended" status. The "Standard" version fulfils the requirements of a debugged application system as described before. The "Extended" version is considered to support testing of not yet fully debugged applications. It comprises extended error checking compared to the standard version.

The sequence of error checking within the NM module is not specified. If multiple errors occur, the status returned depends on the implementation.

In case of fatal errors, the system service does not return to the application. Fatal error treatment is performed by the operating system.

4.2.4. Structure of the Description

The descriptions of NM services are logically grouped. A coherent description is provided for all services of the configuration management, the management of operating modes and data field management.

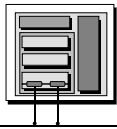

The description of each of these logical groups starts with a description of the data types defined for the group. That section is followed by a description of the group specific system generation support and subsequently the run time services are described.

4.2.4.1. System Generation Support

The description of system generation actions comprises the following fields:

Name:	Name of system generation action
Syntax:	Call interface in C syntax
Parameter (In):	List of all input parameters
Description:	Explanation of the function
Particularities:	Explanation of restrictions relating to the utilization

4.2.4.2. Service Descriptions

A service description comprises the following fields:

Service name:	Name of NM service
Syntax:	Interface in ANSI-C syntax. The return value of the service is always of data type <code>StatusType</code> .
Parameter (In):	List of all input parameters.
Parameter (Out):	List of all output parameters. Strictly speaking, transfers via the memory use the memory reference as input parameter and the memory contents as output parameter. To clarify the description, the reference is already specified with the output parameters.
Description:	Explanation of the functionality of NM service.
Particularities:	Explanation of restrictions related to the use of NM service.
Status:	List of possible return values.
Standard:	• List of return values provided in NM standard version.
Extended:	• List of additional return values in NM extended version.

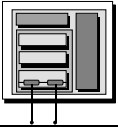

BusShutDown Referenced routine to shut down the bus hardware

Description: *SelectHWRoutines* is a directive to select routines from a given set of routines to drive the bus hardware.

Particularities: none

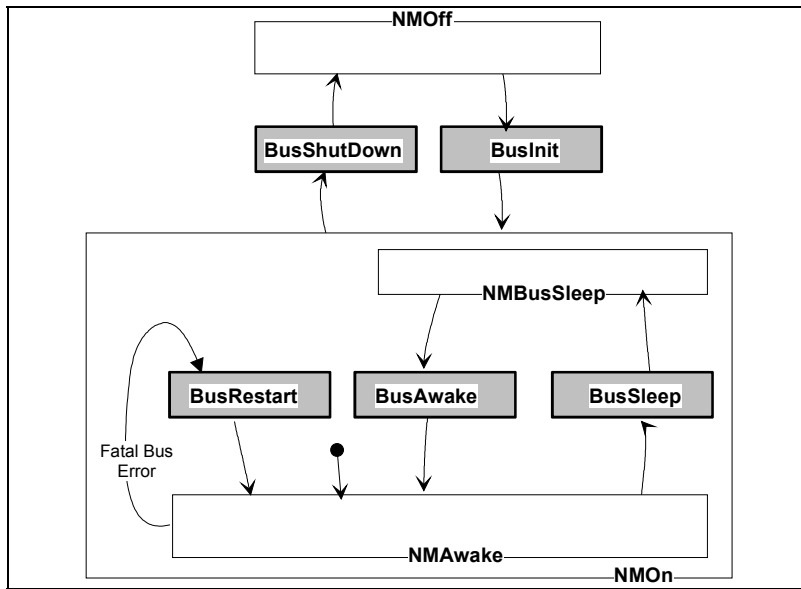

Figure 67

Routines to initialize, restart and shut down the bus hardware.

The routines depend on the given hardware design and on the behavior of the NM which the application requires.

4.4.2. Configuration Management

4.4.2.1. Data Types

NM Data Types	Remark
ConfigRefType	This data type represents the reference of a configuration.
ConfigKindName	Unique name defining the requested kind of configuration: "Normal" supported by direct and indirect NM "Normal extended" only supported by indirect NM "LimpHome" only supported by direct NM.
ConfigHandleType	This data type represents a handle to reference values of the type ConfigRefType.

Table 13 Special data types of the configuration management

4.4.2.2. System Generation Support

Name: **InitCMaskTable**

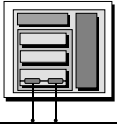

Service name: **CmpConfig**

Syntax: **StatusType CmpConfig (NetIdType <NetId>
ConfigRefType <TestConfig>,
ConfigRefType <RefConfig>,
ConfigRefType <CMask>)**

Parameter(In):

NetId	Addressed communication network
TestConfig	Test configuration
RefConfig	Reference configuration
CMask	List of relevant nodes

Parameter (Out): none

Description: The test configuration <TestConfig> is compared to the specified reference configuration <RefConfig> taking account of the mask <CMask>.

The presence of a node in the network is identified within the test configuration and the reference configuration by TRUE. The relevance of the result of the comparison (<TestConfig> EXOR <RefConfig>) of the node within the network is identified within the <CMask> by TRUE.

Status = NOT (<CMask> AND (<TestConfig> EXOR <RefConfig>))

Example

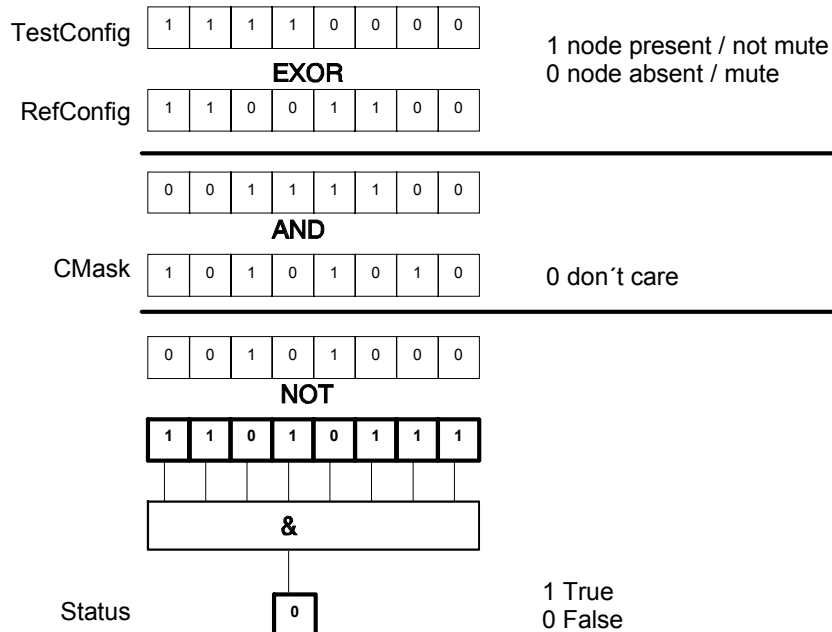

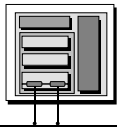

4.4.3.2. System Generation Support

4.4.3.3. Services

Service name: **StartNM**

Syntax: StatusType StartNM (NetIdType <NetId>)

Parameter (In):
NetId Addressed communication network

Parameter (Out): none

Description: *StartNM* starts the local network management. This causes the state transition from NMOff to NMOOn.

Particularities: none

Status:

Standard: • E_OK, no error.

Extended: • none

Service name: **StopNM**

Syntax: StatusType StopNM (NetIdType <NetId>)

Parameter (In):
NetId Addressed communication network

Parameter (Out): none

Description: *StopNM* stops the local network management. This causes the state transition from NMOOn to NMShutDown and after processing of the shutdown activities to NMOOff.

Particularities: none

Status:

Standard: • E_OK, no error.

Extended: • none

Service name: **GotoMode**

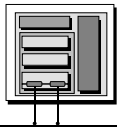

Service name: **CmpStatus**

Syntax: StatusType CmpStatus (NetIdType <NetId>
StatusRefType <TestStatus>,
StatusRefType <RefStatus>,
StatusRefType <SMask>)

Parameter(In):

NetId	Addressed communication network
TestStatus	Test status
RefStatus	Reference status
SMask	List of relevant states

Parameter (Out): none

Description: The test status <TestStatus> is compared to the specified reference status <RefStatus> taking account of the mask <SMask>.

$$\text{Status} = \text{NOT} (\text{<SMask>} \text{ AND } (\text{<TestStatus>} \text{ EXOR } \text{<RefStatus>}))$$

Example

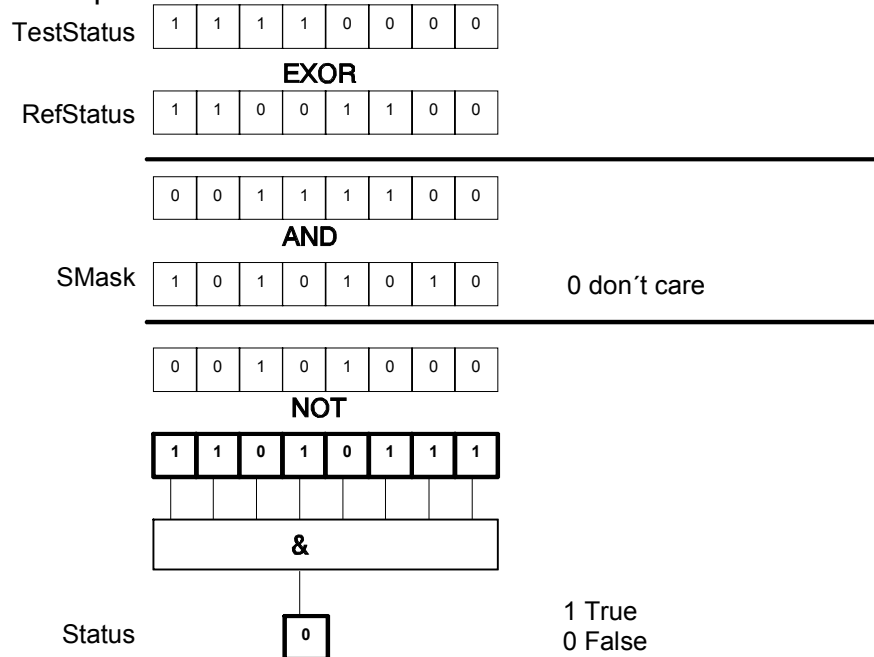

Status:

- Standard:
- TRUE, test condition for specified mask exists.
 - FALSE, else.

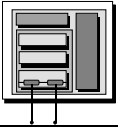

Extended: none

Service name: **SelectDeltaStatus**

Syntax: StatusType SelectDeltaStatus (NetIdType <NetId>,
StatusHandleType <StatusHandle>,
StatusHandleType <SMaskHandle>

Parameter(In):

NetId Addressed communication network
StatusHandle Referenced target network status
SMaskHandle Referenced network status mask

Parameter (Out): none

Description: A set of predefined parameter is selectable to drive the signaling of changed states.

Status: none

4.5. Services for direct NM

4.5.1. Standard Functionality

4.5.1.1. System Generation Support

Name: **InitDirectNMParams**

Syntax: InitDirectNMParams (NetIdType <NetId>,
NodeIdType <NodeId>,
TickType <TimerTyp>,
TickType <TimerMax>,
TickType <TimerError>,
TickType <TimerWaitBusSleep>
TickType <TimerTx>

Parameter (In):

NetId Addressed communication network
NodeId Relative identification of the node-specific NM messages
TimerTyp Typical time interval between two ring messages

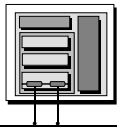

TimerMax	Maximum time interval between two ring messages
TimerError	Time interval between two ring messages with NMLimpHome identification
TimerWaitBusSleep	Time the NM waits before transmission into the state NMBusSleep
TimerTx	Delay to repeat transmission requests

Description: *InitDirectNMPParams* is a directive for initializing the parameters of the direct NM.

Particularities: none

4.5.2. Operating Modes and Operating Mode Management

4.5.2.1. Services

Service name: **SilentNM**

Syntax: StatusType SilentNM (NetIdType <NetId>)

Parameter (In):
NetId Addressed communication network

Parameter (Out): none

Description: *SilentNM* disables the communication of the NM. This causes the state transition from NMActive to NMPassive.

Particularities: none

Status:

Standard: • E_OK, no error.

Extended: • none

Service name: **TalkNM**

Syntax: StatusType TalkNM (NetIdType <NetId>)

Parameter (In):
NetId Addressed communication network

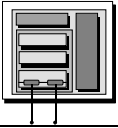

Parameter (Out): none

Description: *TalkNM* enables the communication of the NM again, after a previous call of *SilentNM*. This causes the state transition from NMPassive to NMActive.

Particularities: After a call of *StartNM* the NM is always in state NMActive.

Status:

Standard: • E_OK, no error.

Extended: • none

4.5.3. Data Field Management

4.5.3.1. Data Types

NM Data Types	Remark
RingDataType	Type of the data field in the NMPDU

Table 15 Special data types of the data field management

4.5.3.2. System Generation Support

Service name: **InitIndRingData**

Syntax: `InitIndRingData (NetIdType <NetId>
SignallingMode <SMode>,
TaskRefType <TaskId>,
EventMaskType <EMask>)`

Parameter (In):

NetId Addressed communication network

SMode Mode of signaling

TaskId Reference to the task to be signaled

EMask Mask of the events to be set

Description: *InitIndRingData* is a directive for specifying the indication of received data in the data field of a ring message, which is addressed to this node.

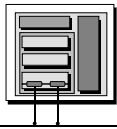

The parameter <SMode> specifies whether task activation (SMode = Activation) or event signaling (SMode = Event) is used for indication.

In case of task activation, <TaskId> contains a reference of the task to be activated if the NM received ring data.

In case of event signaling, <EMask> specified the event to be set for task <TaskId> if the NM received ring data.

Particularities: none

4.5.3.3. Services

Service name: **ReadRingData**

Syntax: StatusType ReadRingData (NetIdType <NetId>
RingDataType <RingData>)

Parameter (In):
NetId Addressed communication network

Parameter (Out):
RingData Contents of the data field within the Network management that contains the data either received by the last NM message or written to by TransmitRingData

Description: *ReadRingData* enables the application to read the data that has been received by a ring message.

Particularities: none.

Status:
Standard:

- E_OK, no error.
- E_NotOK
 - the NM does not pass a ring message currently
 - the logical ring does not run in a stable state.

Service name: **TransmitRingData**

Syntax: StatusType TransmitRingData (NetIdType <NetId>
RingDataType <RingData>)

Parameter (In):

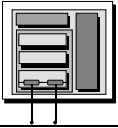

RingData	Data which is written to the data field to be transmitted with the next ring message.
NetId	Addressed communication network
Parameter (Out):	none
Description:	This service enables the application to transmit data via the ring message.
Particularities:	none
Status:	
Standard:	<ul style="list-style-type: none">• E_OK, no error.• E_NotOK<ul style="list-style-type: none">- the NM does not pass a ring message currently- the logical ring does not run in a stable state.

4.6. Services for indirect NM

4.6.1. Standard functionality

4.6.1.1. System Generation Support

Name: **InitIndirectNMPParams**

Syntax: `InitIndirectNMPParams (NetIdType <NetId>,
NodIdType <NodId>,
TickType <TOB>,
TickType <TimerError>,
TickType <TimerWaitBusSleep>`

Parameter (In):	
NetId	Addressed communication network
NodId	Relative identification of the node-specific NM messages
TOB	Time to monitor a subset of nodes.
TimerError	Time interval before reinitializing the bus hardware after an error which makes the NM shift to LimpHome
TimerWaitBusSleep	Time the NM waits before transmission in NMBusSleep

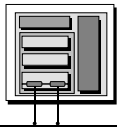

Description: *InitIndirectNMParams* is a directive for initialising the parameters of the indirect NM.

Particularities: none

4.6.2. Configuration Mangement

4.6.2.1. System Generation Support

The determination of the monitored messages which are used by the indirect NM is located and described by the system generation of COM.

Name: **InitExtNodeMonitoring**

Syntax: `InitExtNodeMonitoring (NetIdType <NetId>,
NodeIdType <NodeId>,
Int <DeltaInc>
Int <DeltaDec>`

Parameter (In):

NetId	Addressed communication network
NodeId	Relative identification of the node-specific NM messages
DeltaInc	Value to increment the node status counter when a message is not received during a given time.
DeltaDec	Value to decrement the node status counter when a message is received.

Description: *InitExtNodeMonitoring* is a directive for initializing a set of parameters to monitor one node with an individual time-out. The (redundant) parameter "threshold" is hidden.

Particularities: none

5. Impacts upon OS, COM and the data link layer

5.1. Error Codes

The NM supports several mechanisms to pass errors inside the NM to the application:

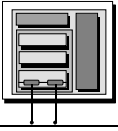

- return value⁵ of the API-services
- indications which are activated by the NM if required configurations or network states are not recognized by the NM

The NM does not support centralized error handling by the application:

- not any error-hook specific to NM
- not a common error-hook used by OS, COM and NM
- services to pass kernel errors to the application are not supported
- the handling of NM kernel errors are up to the implementers

5.2. Common impacts

5.2.1. Requirements of the data link layer

D_Init

From the NM point of view, five services to initialize the DLL are needed in general. Parameter are adjusted according to the following examples:

- baud rate
- sample point
- sample algorithm
- synchronization mechanism
- bit timing
- Sleep Mode of the protocol circuit
- Sleep Mode of the physical layer
- Standby Mode of the physical layer
- operation modes of the protocol circuit

example

parameter (in)	NetId	connected bus (not necessary when just one bus is connected)
----------------	-------	--

⁵ see “Error Codes” inside the document “binding”

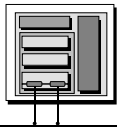

InitRoutine	BusInit	initialize the bus hardware once at the start of the network
	BusShutDown	shut down the bus hardware
	BusRestart	restart the bus hardware in the case of a fatal bus error
	BusSleep	initialize the power down mode of the bus hardware
	BusAwake	reinitialize the bus hardware to leave the power down mode

D_Status.ind

Indication of states of the data link layer (software and hardware) according to the following examples:

- errors from the physical layer
- errors from bus monitoring circuits
- errors from the protocol circuit (CAN e.g.: bus off or error active/passive)
- errors from the DLL
- wake-up signal

example

parameter (out)	NetId	connected bus (not necessary when just one bus is connected)
	status	hardware specific status data

D_GetLayerStatus

Reading the status information of the data link layer according to the following examples:

- interrupt acknowledge to the protocol circuit
- get the status of the protocol circuit, e.g. transmit, receive, overrun, bus off
- get the status of the physical layer, e.g. transmission line error

example

parameter (in)	NetId	connected bus (not necessary when just one bus is connected)
parameter (out)	status	hardware specific status data

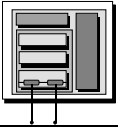

D_Offline

This service allows the user transmission via the data link layer at least to be blocked.

example

parameter (in) NetId connected bus (not necessary when just one bus is connected)

D_Online

This service enables the user communication on the data link layer, e.g. after a call of D_Offline.

example

parameter (in) NetId connected bus (not necessary when just one bus is connected)

The NM calls DLL services at the transition from one state to another state.

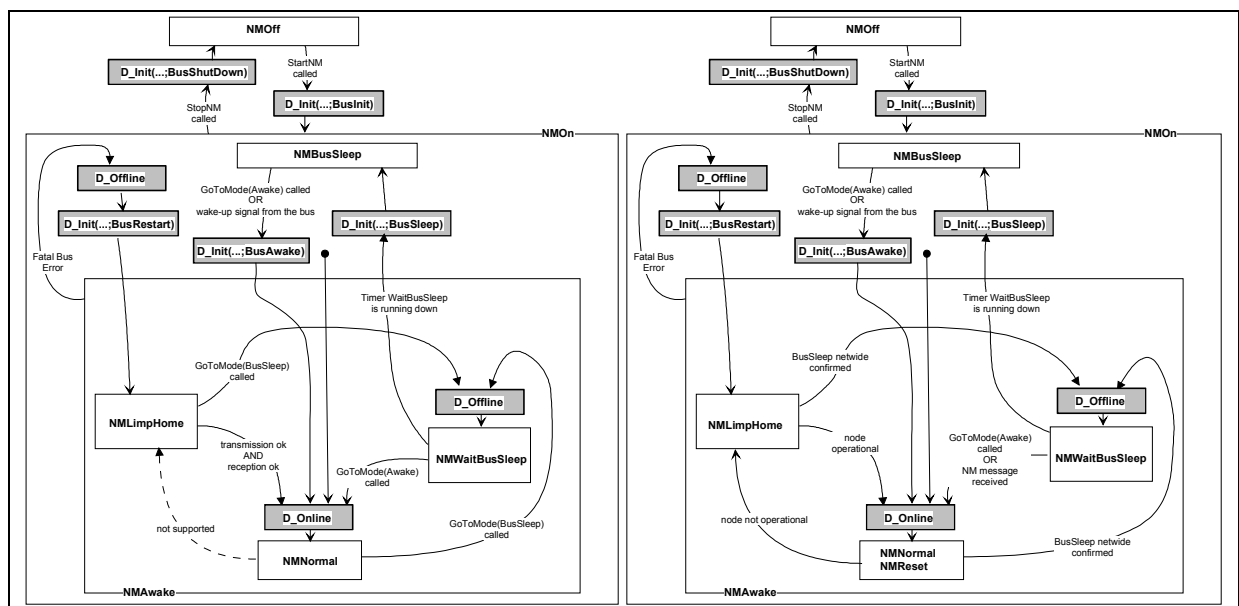
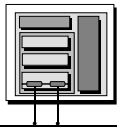

Figure 68 Using of DLL services by the NM
left indirect NM
right direct NM

5.2.2. Requirements of OSEK Operating System (OSEK OS)

The operating system requirements for implementation of OSEK NM are listed below. The standard services for configuration management, management of operating modes and data field management are available at the lowest conformance class BCC1 of OSEK OS. This allows the implementation of NM on the basis of OSEK OS class BCC1. Additional features partly require higher conformance classes.



If NM uses the event triggering mechanism, then this feature is required from the operating system.

The implementation can also be based on a non OSEK OS, which at least provides the functionality of OSEK OS services listed below.

- Alarm services: SetRelAlarm and CancelAlarm
- Task management: GetTaskState, DeclareTask, ActivateTask, TerminateTask and ChainTask.

5.3. Impacts from direct NM

5.3.1. Interface to the data link layer

From the NM point of view the NM in a node has to transmit a NMPDU to the bus and has to receive every NMPDU from the NMs in all networked nodes. The structure of the NMPDU is fixed by the NM. However the data representation inside a NMPDU and how to code/decode a NMPDU to a message is out of the scope of the NM. The annex contents proposals to handle these tasks.

topic	responsible
structure of the NMPDU <i>example</i> Address-Field (source and destination) Control-Field (12 message types) optional Data-Field	OSEK NM
data representation inside the NMPDU	out of the scope of OSEK NM
coding and decoding of a NMPDU to a message	out of the scope of OSEK NM

Table 16 NMPDU - responsible

In general the interface between NM and the DLL to transmit and receive NMPDUs will be directly influenced by the agreement to fix the data representation inside a NMPDU and the coding/decoding to a message.

Based on the experiences according to the state of the art and the proposals given in the annex an interface between NM and the DLL can be suggested.

D_DefineWindow

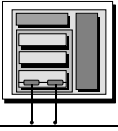

Definition of the encoding/decoding algorithm to broadcast/receive the NMPDU via the bus. This action will be handled by a system generation tool. The system generator is responsible for the selected algorithm.

example

static parameter (in)	NetId	connected bus (not necessary when just one bus is connected)
	WindowMask	mask for filtering NM messages
	IdBase	base identification of an NM message
	SourceId	identification of the source of the NMPDU
	DataLengthTx	number of bytes of the NMPDU to transmit (if data length is static)
	DataLengthRx	number of bytes of the NMPDUs to receive (if data length is static)

D_Window_Data_req

Service to transmit a NMPDU to the network.

example

parameter (in)	NetId	connected bus (not necessary when just one bus is connected)
	NMPDU	except the source (static see the example D_Define_Window, DataLengthTx)
	DataLengthTx	number of bytes of the NMPDU to transmit (if data length is dynamic)

D_Window_Data_ind

Service to receive a NMPDU to the network.

example

parameter (in)	NetId	connected bus (not necessary when just one bus is connected)
parameter (out)	NMPDU	number of bytes referenced by the value DataLengthRx (static see the example D_Define_Window)
	DataLengthRx	number of bytes of the NMPDUs to receive (if data length is dynamic)

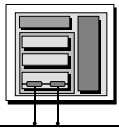

5.4. Impacts from indirect NM

5.4.1. Interface to OSEK Communication (OSEK COM)

When a monitored application message is received/transmitted by COM, indirect NM has to be informed. In case of using one dedicated time-out per message monitored, indirect NM has to be informed when a monitoring time-out expires.

For each of these situations the indirect NM needs to know to which NetId and NodeId the monitored message refers. COM provides this information to NM via a parameter called "Sender", corresponding to a combination of both NetId and NodeId.

Services needed between indirect NM and COM depend on the selected monitoring scheme (one global time-out / one dedicated time-out per monitored message).

Interface to OSEK COM IL	Options	
	One global time-out	One dedicated time-out per monitored message
I_MessageTransfer.ind	core	core
I_MessageTimeOut.ind		core

Table 17 Interface of indirect OSEK NM with OSEK IL

I_MessageTransfer.ind

Indication from COM that a monitored message has been received from a remote node or that the local monitored message has been transmitted.

parameter (out) Sender combination of NodeId and NetId

I_MessageTimeOut.ind

Indication from COM that a time-out at monitoring a message from a remote node has expired or that the time-out at monitoring the local message transmission has expired.

parameter (out) Sender combination of NodeId and NetId

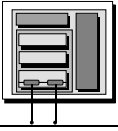

5.4.1.1. Mapping NodeId, NetId ↔ Sender

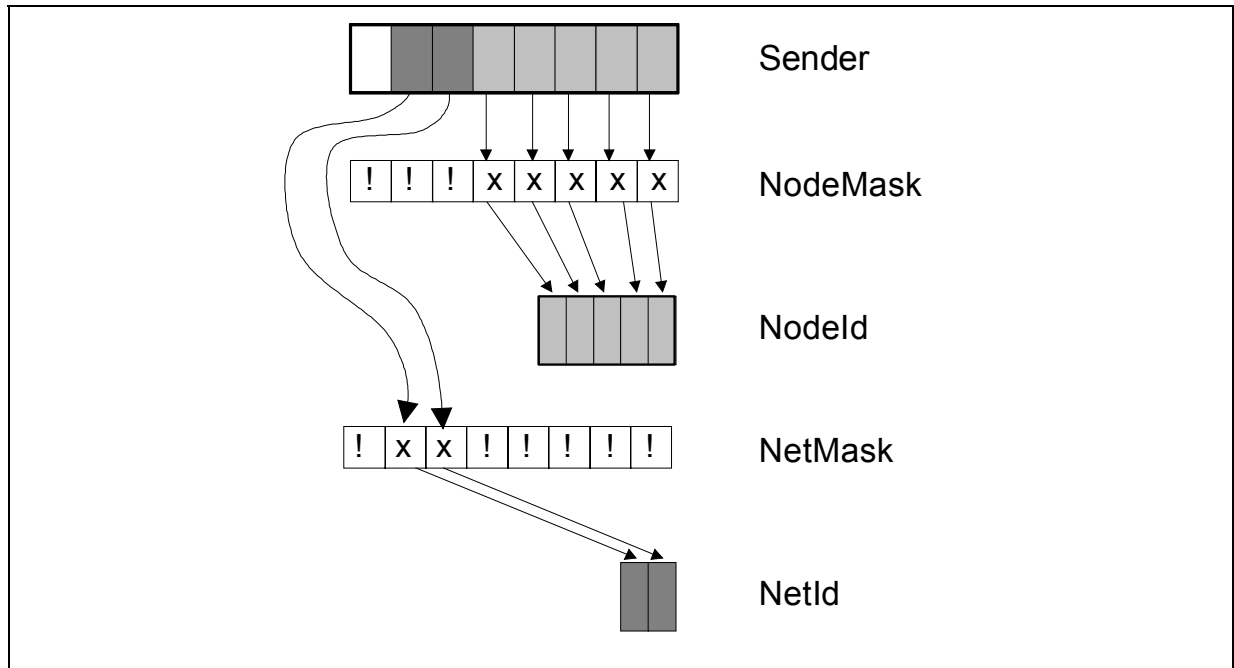

Figure 69 Encoding and decoding of sender to a NodeId and a NetId by using a mechanism with a Mask.
(x = don't care, take Message bit; ! = do not take this bit)

NMDefineNetNodeMapping

Definition of the algorithm to map a sender to a node and to a net. This action will be handled by a system generation tool. The system generator is responsible for the selected algorithm.

example

static parameter (in)	NetMask	mask for filtering NM messages
	NodeMask	mask for filtering NM messages

NMNetNodeMapping

Mapping of a given sender to the corresponding node and the corresponding net.

example

parameter (in)	sender	
parameter (out)	NodeId	node which corresponds to the referenced identification
	NetId	connected bus (not necessary when just one bus is connected)

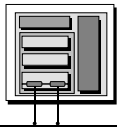

6. History

Version	Date	Remarks
1.00	11 th Sept. 1995	initial release Authors involved in version 1.00 Christoph Hoffmann Volkswagen AG Jürgen Minuth Daimler-Benz AG Josef Krammer BMW AG Jörg Graf Adam Opel AG Karl Joachim Neumann IIT, Univ. of Karlsruhe François Kaag PSA Peugeot Citroën
2.00	24 th Dec. 1996	
2.10	4 th April 1997	Authors involved in Version 2.0 and 2.1 Josef Krammer BMW AG Jürgen Minuth Daimler-Benz AG Ansgar Maisch IIT, University of Karlsruhe Willy Roche IIT, University of Karlsruhe Christoph Hoffmann Volkswagen AG Olivier Quelenis Magneti Marelli Eric Farges Renault Peter Aberl Texas Instruments
2.50 preliminary	31 st March 1998	Authors involved in Version 2.5 Josef Krammer BMW AG Dirk John IIT, University of Karlsruhe Christoph Hoffmann Volkswagen AG Lise Mathieu Renault Jürgen Minuth Daimler-Benz AG Olivier Quelenis Magneti Marelli summary of modifications since Version 2.1 - indirect NM: individual time outs per monitored message - update system generation services - update structure of the document - harmonization of NM services - harmonization interface to COM - update state transition diagrams and SDL diagrams
2.50	31 st May 1998	editorial overworking of the preliminary version 2.50
2.51	31 st May 2000	Results of the harmonization Authors involved in version 2.51 Jürgen Minuth DaimlerChrysler Martin Schütze Robert Bosch AG Dirk Gronemann Siemens
2.5.2	16 th Jan. 2003	Adapt to COM 3.0 editor: Jochem Spohr, IMH

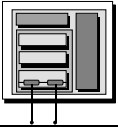

7. Implementation proposal (direct NM)

7.0.1. Overview of Internal Activities

All the internal services of the NM begin with NM. All words of the service name begin with a capital letter.

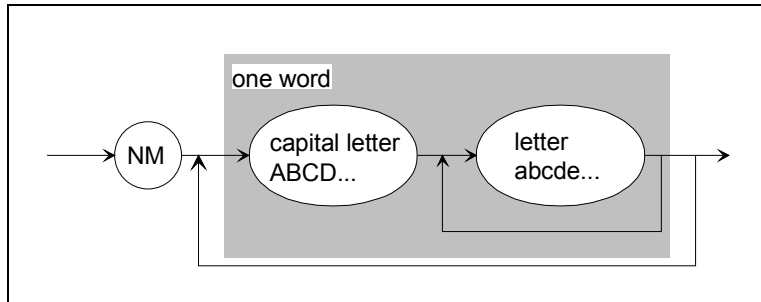

Figure 70

Syntax of the names of internal NM services.

Example:
 NMShutDown

	Activity	Core or Optional
- Shut-off of NM	NMOff	CORE
- Save parameters, store history and shutdown NM	NMShutDown	CORE
- Initialize NM and the resources pertaining to it	NMInit	CORE
- NM in the state NMBusSleep	NMBusSleep	CORE
- NM in the state NMActive	NMActive	CORE
- NM in the state NMPassive	NMPassive	CORE
- NM in the state NM~Standard	NM~Standard	CORE
- NM in the state NM~Active	NM~Active	CORE
- NM in the state NM~Passive	NM~Passive	CORE
- NM in the state NM~ActivePrepBusSleep	NM~ActivePrepBusSleep	CORE
- NM in the state NM~PassivePrepBusSleep	NM~PassivePrepBusSleep	CORE

Table 18 Breakdown of internal NM activities into core services and optional services.

~ Reset, Normal or LimpHome

The state transition diagrams (STD) listed hereafter define system hierarchy and general transition rules for the NM behavior.

NM activities are performed by calls of the internal activities in the respective states of the STD and identified by the names of these dedicated internal activity. Internal activities are defined verbally in the referenced chapters according to the description of their characteristics.

Consequently, they can be considered as macros which are generated at compile time, using (elementary) services which are defined otherwise.

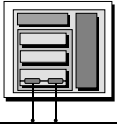

Thus, there is neither an appropriate C syntax, nor specifications about input / output parameters or status of the internal activity.

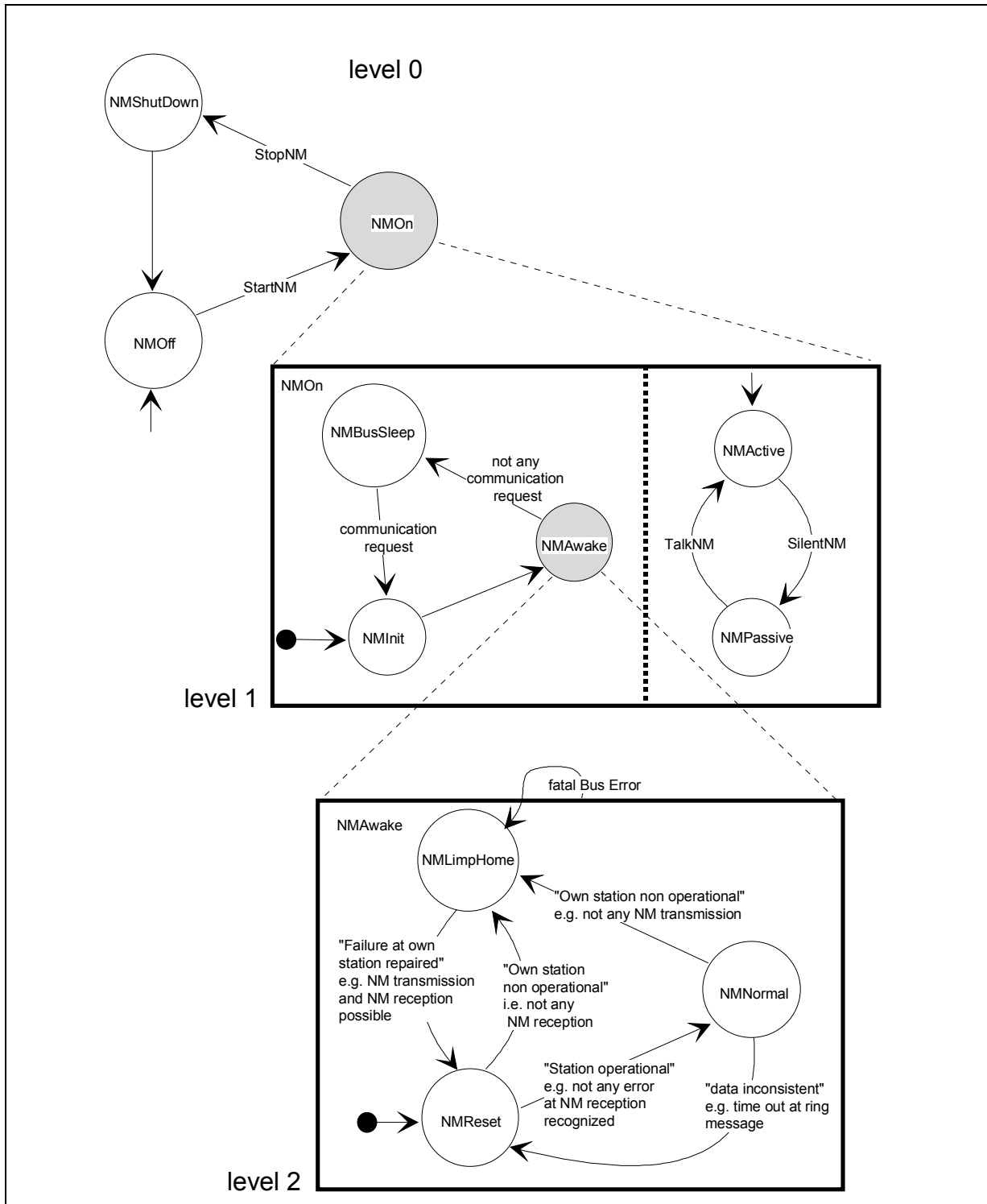

Figure 71 Simplified state transition diagram of the direct NM.

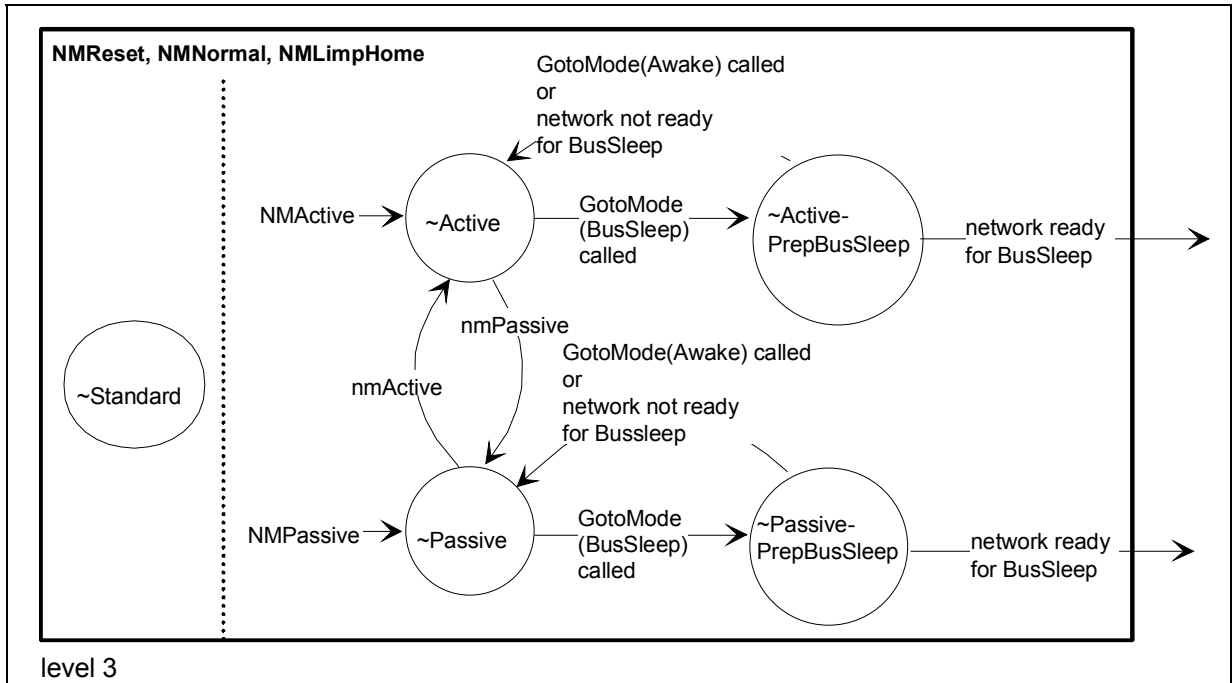
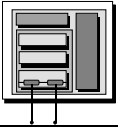

Figure 72 NM internal states "NMNormal" or "NMReset" or "NMLimpHome"

7.0.2. Specification of Internal Activities

Service name: **NMOff**

Description: NM of the node is shut-off.

Particularities: none

Service name: **NMShutDown**

Description: Service for selective shut-off of NM entity. This includes all "clearing-up work" (see below) to be effected by NM.

This service is effected without confirmation throughout the whole network. (see Figure 71)

The tasks of this service comprise:

- Saving NM state incl. the last valid network configuration, operating state, version number (optional, depending on system design).
- Releasing all resources assigned for NM.
- Reset interface module.

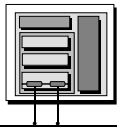

Particularities: none

Service name: **NMInit**

Description: Service for initializing NM according to NM STD:

- Initialization of network interface.
- Assignment and initialization of NM resources.

Particularities: none

Service name: **NMBusSleep**

Description: The NM module of the node is mode NMBusSleep according to the NM STD (level 1).

Particularities: Concrete procedures must be specified by the respective system responsible.

Service name: **NMActive**

Description: The NM module of the node is mode NMActive according to the NM STD (level 1).

Particularities: Concrete procedures must be specified by the respective system responsible.

Service name: **NMPassive**

Description: The NM module of the node is mode NMPassive according to the NM STD (level 1).

Particularities: Concrete procedures must be specified by the respective system responsible.

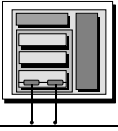

Service name: **NMNormalActivePrepBusSleep**

Description: The NM module of the node is mode NMNormalActivePrepBusSleep according to the NM STD (level 3).

The activities performed are according to the concept of OSEK NM the notification of a sleep request for the whole network to all nodes in the network and pending for confirmation.

Particularities: Concrete procedures must be specified by the respective system responsible.

Service name: **NMLimpHomeActivePrepBusSleep**

Description: The NM module of the node is mode NMLimpHomeActivePrepBusSleep according to the NM STD (level 3).

The activities performed are according to the concept of OSEK NM the notification of a sleep request for the whole network to all nodes in the network and pending for confirmation.

Particularities: Concrete procedures must be specified by the respective system responsible.

Service name: **NMResetActivePrepBusSleep**

Description: The NM module of the node is mode NMResetActivePrepBusSleep according to the NM STD (level 3).

The activities performed are according to the concept of OSEK NM the notification of a sleep request for the whole network to all nodes in the network and pending for confirmation.

Particularities: Concrete procedures must be specified by the respective system responsible.

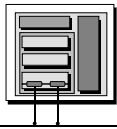

- Service name: **NMNormalPassivePrepBusSleep**
- Description: The NM module of the node is mode NMNormalPassivePrepBusSleep according to the NM STD (level 3).
- Particularities: Concrete procedures must be specified by the respective system responsible.
-
- Service name: **NMLimpHomePassivePrepBusSleep**
- Description: The NM module of the node is mode NMLimpHomePassivePrepBusSleep according to the NM STD (level 3)
- Particularities: Concrete procedures must be specified by the respective system responsible.
-
- Service name: **NMResetPassivePrepBusSleep**
- Description: The NM module of the node is mode NMResetPassivePrepBusSleep according to the NM STD (level 3)
- Particularities: Concrete procedures must be specified by the respective system responsible.
-
- Service name: **NMNormalActive**
- Description: The NM module of the node is mode NMNormalActive according to the NM STD (level 3).
- The procedure performed is to participate in the NM communication according to the logical ring concept and to assess the NMPDU.
- Particularities: none

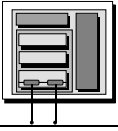

Service name: **NMLimpHomeActive**

Description: The NM module of the node is mode NMLimpHomeActive according to the NM STD (level 3).

The procedure performed is to participate in the NM communication according to the logical ring concept and to assess the NMPDU.

Particularities: none

Service name: **NMResetActive**

Description: The NM module of the node is mode NMResetActive according to the NM STD (level 3).

The procedure performed is to participate in the NM communication according to the logical ring concept and to assess the NMPDU.

Particularities: none

Service name: **NMNormalPassive**

Description: The NM module of the node is mode NMNormalPassive according to the NM STD (level 3).

Particularities: none

Service name: **NMLimpHomePassive**

Description: The NM module of the node is mode NMLimpHomePassive according to the NM STD (level 3).

Particularities: none

Service name: **NMResetPassive**

Description: The NM module of the node is mode NMResetPassive according to the NM STD (level 3).

Particularities: none

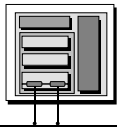

Service name: **NMNormalStandard**

Description: The NM module of the node is mode NMNormalStandard according to the NM STD (level 3).

Particularities: none

Service name: **NMLimpHomeStandard**

Description: The NM module of the node is mode NMLimpHomeStandard according to the NM STD (level 3).

Particularities: none

Service name: **NMResetStandard**

Description: The NM module of the node is mode NMResetStandard according to the NM STD (level 3).

Particularities: none

7.0.3. NMPDU

OSEK implementation of direct node monitoring supports the implementation of NMPDU as listed hereafter.

Additional information for extended NM features, e.g. dedicated enhanced diagnosis support, could be mapped into the data field of the NM message. This is an optional feature in the responsibility of the respective system developer and it depends on the used bus protocol.

Implementation

The implementation features

- support of a maximum number of 256 nodes
- demand of 3 Bytes

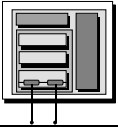

Addressing Field		Control Field	Data Field (optional)
8 bit	8 bit	8 bit	specific to the protocol (e.g. CAN)
Source Id	Destination Id	OpCode	Data

Figure 73 Implementation of NMPDU

7.0.3.1. OpCode

Address Field		Control Field			Data Field					
Source Id	Dest. Id	OpCode			Data					
mandatory					optional					
		Coding Example		Interpretation						
		0	0	0	0	0	0	1	Ring Message, cleared Bussleep.ack, cleared Bussleep.ind	0
		0	0	0	0	0	1	0	1	Ring Message, cleared Bussleep.ack, set Bussleep.ind
		0	0	0	0	0	x	1	1	Ring Message, set Bussleep.ack
		0	0	0	0	0	0	1	0	Alive Message, cleared Bussleep.ind
		0	0	0	0	0	1	1	0	Alive Message, set Bussleep.ind
		0	0	0	0	0	0	0	0	Limp Home Message, cleared Bussleep.ind
		0	0	0	0	0	1	0	0	Limp Home Message, set Bussleep.ind

Table 19 NMPDU

The 1st 5 bits of the OpCode are reserved for future extensions. They should be initialized to logical zero. The data field should be initialized to logical zero

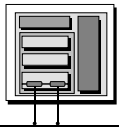

7.0.3.2. Encoding and decoding

7.0.3.2.1. Addressing Mechanisms

The following set-up is required **for each node** to implement the window mechanism with a broadcast behavior:

- one node-specific transmit object
- one or more global receive objects (windows) for all node-specific NM messages

Under worst case condition NM has to use a range of message headers for network-wide communication. Such a range of messages can be mapped to one or more window objects. Each window object is identified by the values:

- IdBase Base identification of any NM message header.
- WindowMask Mask for filtering NM messages (acceptance).

Example for Acceptance Filtering

Reception is OK: IF(Id_of_Frame & WindowMask == IdBase)

Example for encoding and decoding of a NMPDU

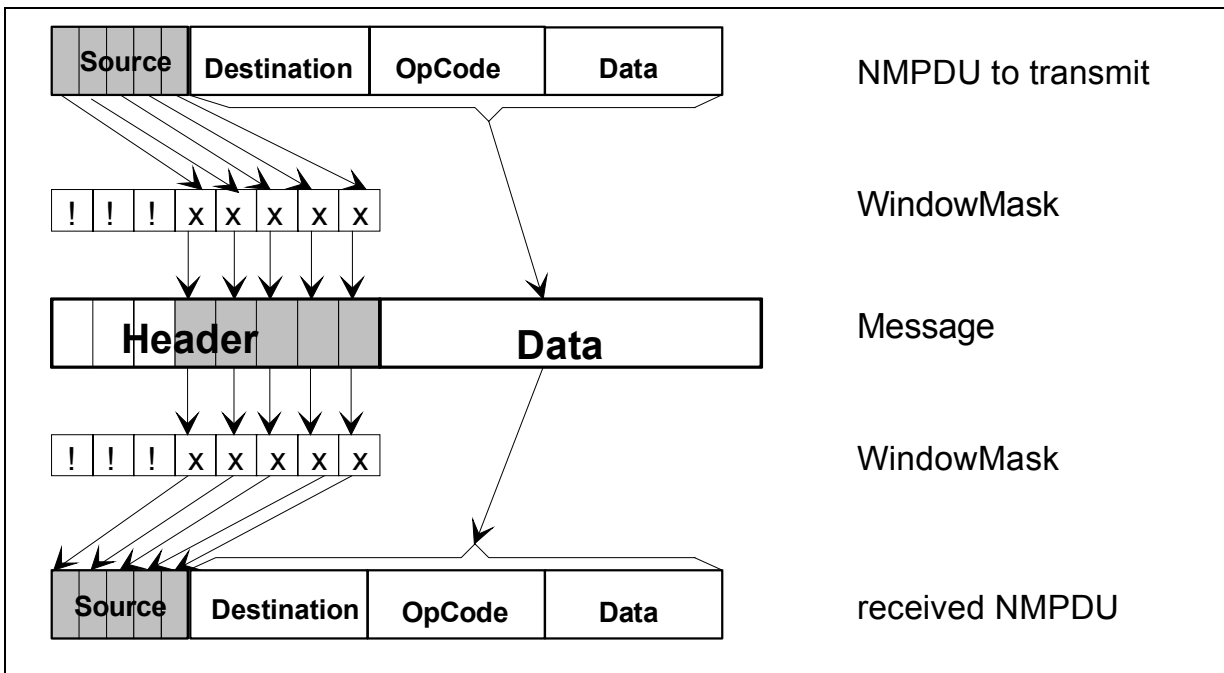
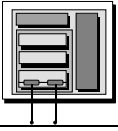

Figure 74 Encoding and decoding of the NMPDU to a message by using the window mechanism with IdBase and WindowMask.
(x = don't care, take NMPDU bit; ! = take original bit of IdBase)

The example shows, that the receiving node can determine parts of the NMPDU, e.g. the identification of the transmitting node, from the transmitted frame.

7.0.3.2.2. Coherent Allocation of NM message Headers



A simple implementation results if the message headers for NM are selected in a coherent numeric range.

Two integers n and k must be selected in order to enable straightforward acceptance filtering of NM messages.

Using the constant n , 2^n (WindowSize) directly addressable nodes are made available. The constant k defines the Base of the message header as an integer multiple of the maximum number of directly addressable nodes.

Node identification	$0 \dots 2^n - 1$
IdBase	$k \cdot 2^n$
least message header	$k \cdot 2^n + 0$
greatest message header	$k \cdot 2^n + 2^n - 1$

Table 20 Selection of message headers and NodeNumbers

General Example

Addressing of 32 separate nodes shall be enabled. The NM message headers have to start with message identifier 600hex. This implies:

- Selected parameters: $32 = (2^5) \Rightarrow n = 5$
 $600\text{hex} = (48 \cdot 32) \Rightarrow k = 48.$
- Node identification $0 \dots 31$ dec
- Least header (600hex) $110\ 0000\ 0000$ bin, $110\ 000$ bin corresponds to k
- Greatest header (61Fhex) $110\ 0001\ 1111$ bin
- IdBase $110\ 0000\ 0000$ bin
- WindowMask $111\ 1110\ 0000$ bin "1" : target
"0" : don't care

CAN Example

A NM message containing the NMPDU has to be mapped into diverse bus protocols. The figures below show a CAN realization example (i.e. max. 256 nodes can be addressed). Because CAN implementations do not allow unique message identifiers used by more than one transmitter, it is essential that all NM messages differ from each another. This can be achieved by e.g. encoding the NM Source Id into the CAN message Id.

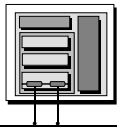

CAN Identifier		DLC	CAN Data Field		
11 (29) bit		4 bit	≤ 64 bit		
	Addressing Field		Control Field	Data Field	
3 (21) bit	8 bit		8bit	8bit	48bit
IdBase	Source Id		Dest. Id	OpCode	Data
x	S	8	D	x	x

Figure 75 Structure of NM message in case of CAN (6 Byte Data Field).

CAN Identifier		DLC	CAN Data Field		
11 (29) bit		4 bit	16 bit		
	Addressing Field		Control Field		
3 (21) bit	8 bit		8bit	8bit	
IdBase	Source Id		Dest. Id	OpCode	
x	S	2	D	x	

Figure 76 Structure of NM message in case of CAN (without Data Field).

CAN Identifier		CAN Data Field								
11 (29) bit		3 - 8 byte								
	Address Field		Control Field						Data Field	
3 (21) bit	8 bit	1 byte	1 byte	1 byte				≤ 5 byte		
	Source Id	Dest. Id	OpCode						Data	
	x	D hex	0	0	x	x	x	x	x	Ring Messages
	x	D hex	1	0	x	x	x	x	x	
	x	D hex	0	1	x	x	x	x	x	
	x	D hex	1	1	x	x	x	x	x	
	x	E hex	0	0	x	x	x	x	x	Alive Messages
	x	E hex	1	0	x	x	x	x	x	
	x	C hex	0	0	x	x	x	x	x	Limp-Home Messages
	x	C hex	1	0	x	x	x	x	x	

Figure 77 Example of the mapping of the NMPDU to a NM message based on CAN
 - comparable to the DaimlerChrysler encoding
 x reserved

Important Note:

In principle, message headers required to implement the window can obviously be assigned in any order.

Selecting the digits n and k according to the principle introduced above, the choice is automatically limited to powers of two and enables straightforward filtering for acceptance in the destination system.

In the case of possible dynamic allocations, the window parameters can be coded using two bytes, and can be transmitted with a message.

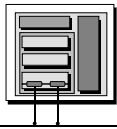

- **Potential function master**
In case of failure of the function master, e.g. node breaks down, each of these back-up masters is capable of performing at least some of the master's functions.
- **Function slaves**

The individual nodes may feature broadly varying available computing power for implementation of NM. The decentralized NM can be scaled to save resources (requirements of RAM/ROM and computer time), resulting in two extreme NM types:

- **Max_NM**
Set of all NM functions according to direct node monitoring.
- **Min_NM**
Minimum set of required functionality enabling participation in direct node monitoring.

The choice of functions can be adapted to the nodes' performance.

Task	Max NM	<i>scaleable</i> →	Min NM
Store the present configuration	✓		-
Time-out monitoring to detect faulty node	✓		-
"Re-login" if skipped	✓		✓
Login	✓		-
Determine logical successor	✓		✓
Delayed transmission of NM message according to sequencing rule of the logical ring	✓		✓
Start up of the logical ring	✓		-

Table 22 Functionality of the configuration algorithms of Max NM and Min NM

If necessary, the individual node types (Function master ... Function slave) can be supplied with subsets of the decentralized NM.

In a centrally structured network, the group of nodes consisting of function master and potential function masters, can be considered as decently structured with regard to the configuration adjustment within the NM.

The dynamic concept of configuration determination enables integration of any function slaves performing Min NM and of any potential function master into the network.

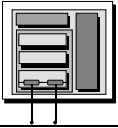

Important Note:

For the sake of clarity, the implementation of identical NM modules is required in each node.

In other words: the basic scalability of the decentralized NM should only be used in vital, exceptional cases.

7.1. Implementation proposal (indirect NM)

7.1.1. Scalability

According to system designer needs and to computing power performance of nodes (RAM/ROM and computer time), Indirect NM can be scaled in NM types ranging from :

- **Max_NM**
Set of all NM functions including all extended features.

down to

- **Min_NM**
Minimum set of required functionality enabling network communication.

Function	Max NM	→ <i>scalable</i> →			Min NM
Hardware initialization, restart of hardware after a failure, bus shutdown	✓	✓	✓	✓	✓
Dynamic states monitoring	✓	✓	✓	✓	-
Static states monitoring	✓	-	✓	-	-
BusSleep	✓	✓	-	-	-

Table 23 Example of functionality for different NM types

Important Note:

The implementation of identical indirect NM type is not required in each node. Choice of functions to be implemented is let to system designer.

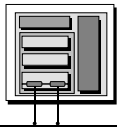

7.1.2. Implementation hints

7.1.2.1. Choice one global time-out / one monitoring time-out per message

Implementing node monitoring functionality, the system designer can choose two monitoring schemes:

- all messages are monitored by one global time-out TOB (time-out for observation)
- each message is monitored by its own dedicated time-out.

One global time-out

- **Advantage**
This solution does not require much micro-controller CPU time resource.
- **Drawback**
If monitored messages have very different transmission period (for example, one 10ms message from a node and one 500ms message from another), the user has to choose the biggest value for timer TOB to be sure than each message has arrived before time - out expires. The resulting delay on the 10ms message monitoring may be unacceptable if this message is time-critical for the application.

One time-out per monitored message

- **Advantage**
Each message can be monitored regarding its time-criticality.
- **Drawback**
This solution requires more micro-controller CPU time resource.

7.1.2.2. Configuration of extended states detection algorithm

Extended states detection algorithm has to be configured at system generation time. Parameters to be set are:

- the Threshold value, which is the same for all counters,
- a DeltaInc (increment of counter) and a DeltaDec (decrement of counter) values per monitored node.

Threshold value is usually set to 255; its value has no impact on the algorithm behaviour. DeltaInc and DeltaDec modify algorithm behaviour.

Examples

- If the system designer needs:
 - "static states" corresponding to states during a unique T_{Static} time value for every monitored node, although these nodes have different transmission periods and are monitored by different time,

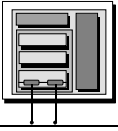

- counters return directly to 0 when static states are left

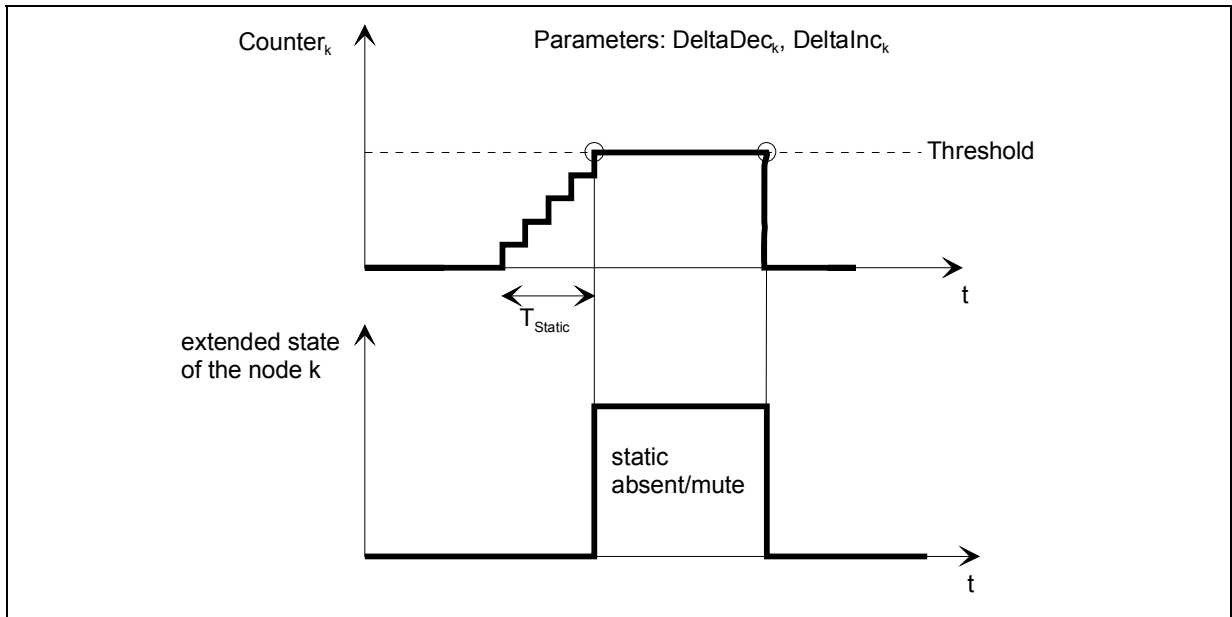

Figure 78 Extended state example one

Parameter of node k	Value
DeltaInc	$\frac{\text{Threshold} \times \text{TimeOut}_k}{T_{\text{Static}}}$
DeltaDec	Threshold

Table 24 Calculation of DeltaInc and DeltaDec according example one
TimeOut_k: monitoring time-out for node k

- If the system designer needs :
 - "static states" corresponding to states during a unique T_{Static} time value for every monitored node, although these nodes have different transmission periods and are monitored by different time-outs,
 - counters keeping track of node states during a T_{Erase} time value after static states are left

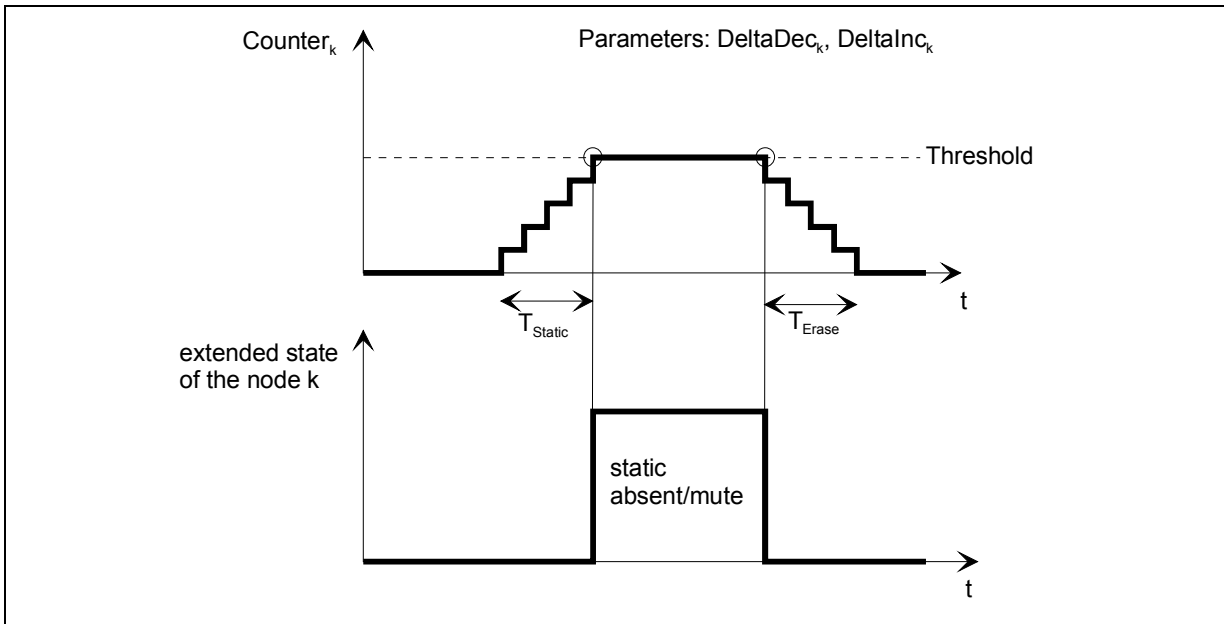
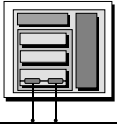

Figure 79 Extended state example two

Parameter for node k	Value
DeltaInc	$\frac{\text{Threshold} \times \text{TimeOut}_k}{T_{Static}}$
DeltaDec	$\frac{\text{Threshold} \cdot T_k}{T_{Erase}}$

Table 25 Calculation of DeltaInc and DeltaDec according example one
 TimeOut_k : monitoring time-out for node k
 T_k : period of the supervised message received from node k

7.1.3. Summary of SDL state diagram graphical notation

The SDL graphical symbols used in the specification of the indirect network management state machine are described below:

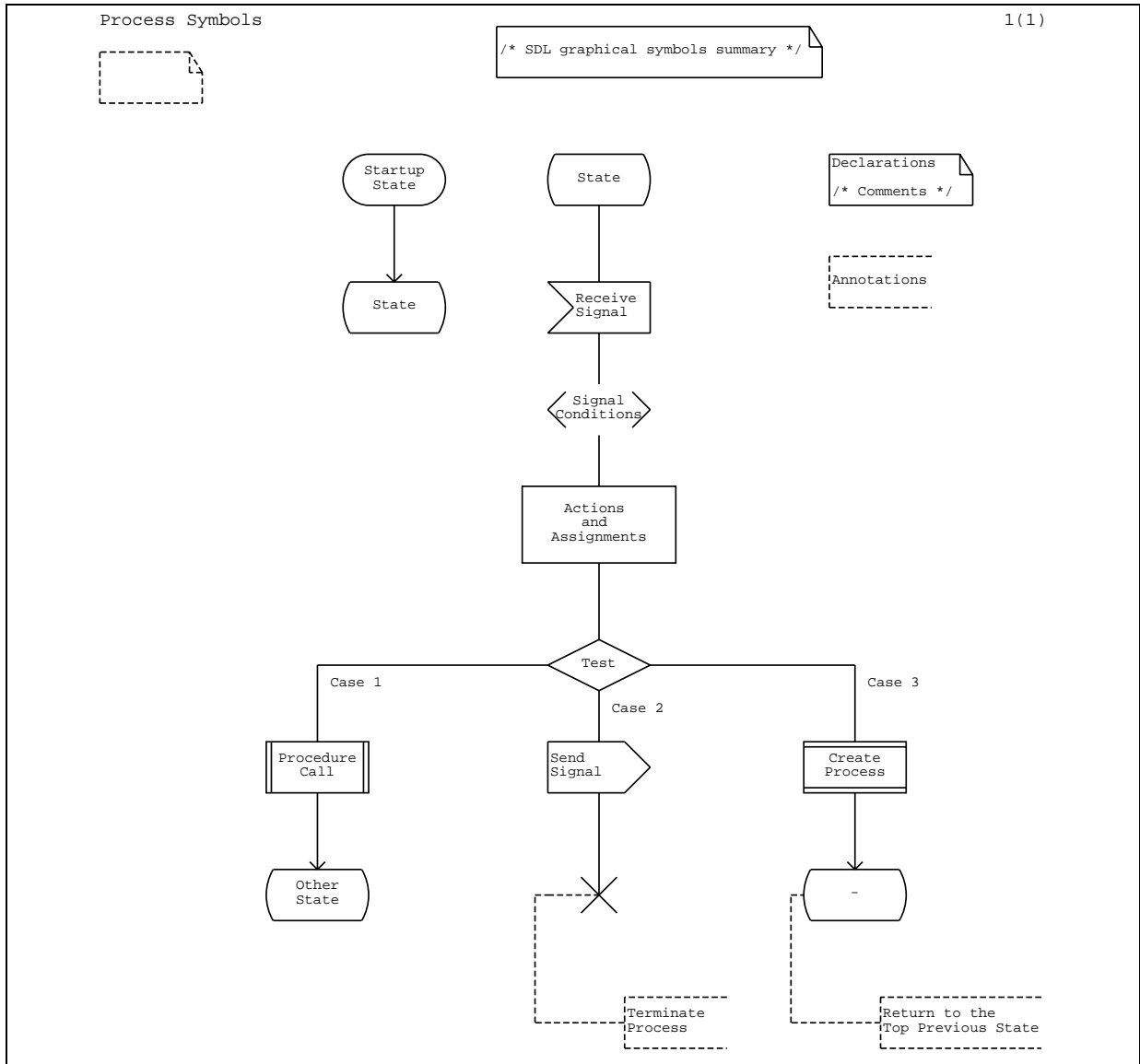
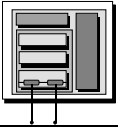
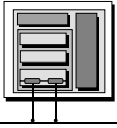

Figure 80 Summary of SDL state diagram graphical notation

7.2. Outlook

The mapping of a NMPDU into a CAN message is on the way to be confirmed among the vehicle manufacturers. Future requirements are visible, first steps to meet them were made:

- *Sub-net operating*
selective wake-up/go-to sleep via the bus lines
→ a subset of nodes is active
→ a subset of nodes is in a low power mode
- *Gateway support*
→ monitoring of nodes across several networks
→ negotiated operating modes across several networks



- *Standardized Data Representation*
 - NMPDU inside a CAN message
 - Network states
 - simple certification
- *API*
 - adding of service-prefix to simplify the readability
 - negotiated operating modes across several networks
 - optimized return value
 - support sub-net operating e. g. by LogOff and LogOn
- *Station Management*
 - e. g. algorithms specific to the application to handle a CAN bus-off

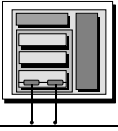

8. Index

List of all network management services, data types and internal activities.

CmpConfig	96	NMNormalStandard	122
CmpStatus	100	NMOff	117
ConfigHandleType	91	NMPassive	118
ConfigKindName	91	NMResetActive	121
ConfigRefType	91	NMResetActivePrepBusSleep	119
EventMaskType	89	NMResetPassive	121
GetConfig	95	NMResetPassivePrepBusSleep	120
GetStatus	99	NMResetStandard	122
GotoMode	98	NMShutDown	117
InitCMaskTable	91	NodeIdType	89
InitConfig	94	ReadRingData	104
InitDirectNMParams	101, 105	RingDataType	103
InitExtNodeMonitoring	106	RoutineRefType	89
InitIndDeltaConfig	92	SelectDeltaConfig	97
InitIndDeltaStatus	94	SelectDeltaStatus	101
InitIndRingData	103	SelectHWRoutines	90
InitNMScaling	90	SignallingMode	89
InitNMType	89	SilentNM	102
InitSMaskTable	93	StartNM	98
InitTargetConfigTable	92	StatusHandleType	97
InitTargetStatusTable	93	StatusType	89
NetIdType	89	StopNM	98
NetworkStatusType	97	TalkNM	102
NMActive	118	TaskRefType	89
NMBusSleep	118	TickType	89
NMInit	118	TransmitRingData	104
NMLimpHomeActive	121		
NMLimpHomeActivePrepBusSleep	119		
NMLimpHomePassive	121		
NMLimpHomePassivePrepBusSleep	120		
NMLimpHomeStandard	122		
NMModeName	97		
NMNormalActive	120		
NMNormalActivePrepBusSleep	119		
NMNormalPassive	121		
NMNormalPassivePrepBusSleep	120		

